

VOLVO PENTA

The art of performance

PROPELLERS





The art of performance

Volvo Penta propellers are an engineering form of art. Behind the slightest curve, smoothest contour and tightest angle is a state-of-the-art design process based on years of experience. Since we develop the entire driveline, we know how to convert power into real performance that leads to greater boating pleasure and at the same time contributes to the long-term health of your driveline.

A wide range of experience

Volvo Penta IPS, Aquamatic Sterndrive, Saildrive and Forward Drive are among the greatest inventions to ever grace the marine industry - advanced and innovative engineering that can only come from extensive experience and an unwavering commitment to deliver greater boating pleasure.

Our propellers are no exception. They are, and have always been, a vital part of this innovative process and have an integral role in changing the definition of performance, comfort and driving pleasure.

The only way forward

For Volvo Penta, propellers will always be designed as a part of a complete propulsion system. It is the only way. Whether you have a powerboat or sailboat, there is a genuine Volvo Penta propeller, designed entirely for your needs.

Double your warranty

Genuine Volvo Penta propellers are covered by our standard 12 month warranty. Have them supplied and installed by an authorized Volvo Penta dealer and we will extend your warranty to 24 months - including the labor.

Consult your local Volvo Penta dealer for more details.

Find your dealer

Your Volvo Penta dealer can help you identify the correct propeller to your driveline. To find your local dealer, visit our web site volvopenta.com and search among our 3,500 dealers worldwide.

Your dealer can also provide you with recommendations and expert advice regarding maintenance and care for your Volvo Penta products.



Contents

Single propellers for Aquamatic sterndrives	4
SX	6
200-290, SP	8
100	10
Duoprop propellers for Aquamatic sterndrives	12
DPS	14
DPH	16
DPI	17
FWD	18
DPR	19
280, 290, DP	20
Propellers for Volvo Penta IPS	22
IPS 1, IPS 10	24
IPS 15	25
IPS 2, IPS 20	26
IPS 3, IPS 30	27
Propellers for S-drives and shafts	30
Folding propellers	32
Fixed propellers	36
Related products	38
Anodes for drives and propellers	38
Line cutter for IPS	40
Grease for propeller components	41
Marine transmission oils	42

Note! For installation instructions, we refer to the operator's manual and additional information that is supplied with the propeller or hardware.

Carefully read the instructions and safety information before starting. The illustrations in this publication are for illustrative purposes only.



Single propellers for Aquamatic sterndrives

Performance perfectly matched

Volvo Penta launched the first single propeller sterndrive in 1959. A lot has changed since then. Though technology continues marching forward, one factor remains the same - the real performance comes from a perfectly matched propeller and driveline.

Genuine Volvo Penta single propellers for Aquamatic Sterndrives are developed exclusively for their drive, matching both engine power and torque. The result is a proven design that ensures optimal performance, fuel economy and comfort along with life expectancy and the peace of mind you expect from Volvo Penta.

Precise balancing gives minimal vibrations, quiet and comfortable operation. It is also essential for efficiency and minimizes wear on the drivetrain.

Shock-absorbing rubber bushing in the hub reduces turning and pulling forces and minimizes stress on the drivetrain caused by gear changes and propeller impact.

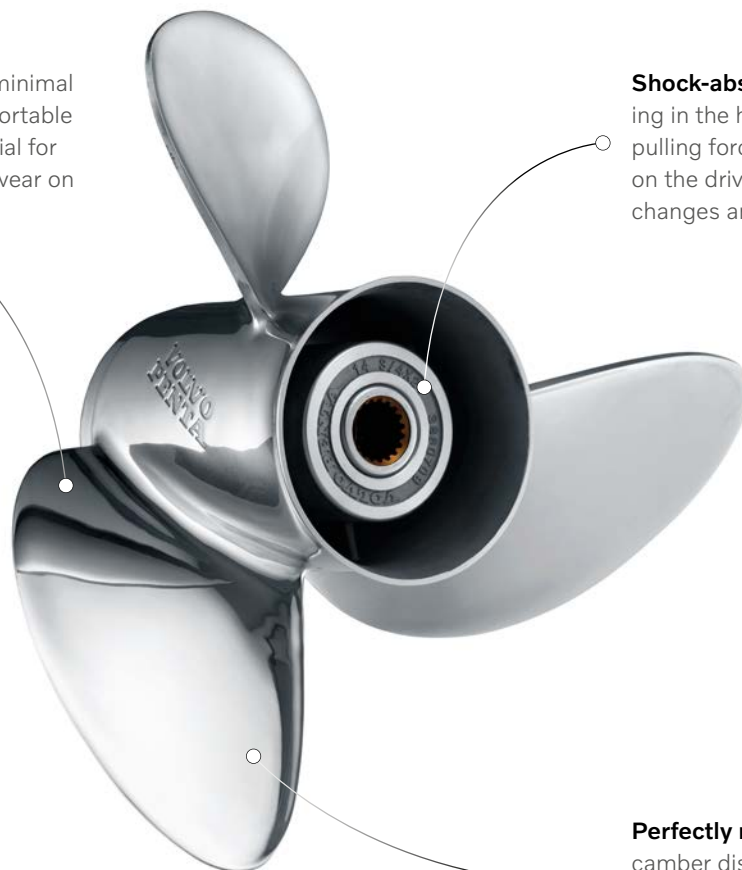

Perfectly matched pitch and camber distribution contributes to excellent propeller grip, optimal operational efficiency, safe and predictable handling.

SX Drives

3-blade aluminum propeller

With its wide and efficient blade design this propeller offers excellent acceleration and top speed. The state-of-the-art squeeze casting process together with special high strength aluminum alloy makes it stronger and more durable than traditional die-cast propellers. Four layers of paint ensure excellent anti-corrosion performance.

- Strong and durable high-performance 3-blade aluminum propeller.
- Wide and efficient blade design providing excellent acceleration and top speed.
- Shock-absorbing rubber bushing reduces vibrations and stress on the drivetrain.
- Four layers of paint ensure excellent anti-corrosion performance.

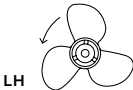
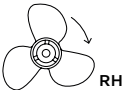

Ø x PITCH	 LH	 RH
14.3 x 21	–	3817469
14.2 x 23	–	3817470
14.5 x 19	3817473	3817468
14.8 x 17	3817472	3817467
15 x 15	3817471	3817466
15 x 16	–	–
15,5 x 12	3855476	–
15.5 x 13	3855477	3840720
15.5 x 14	3855478	–



Installation hardware, see next page.

4-blade aluminum propeller

The four-blade propeller features the same strength and durability as the three-blade propeller. Four blades provide increased torque for heavy loads and maneuverability together with great stern lifting and mid-range performance. Four layers of paint ensure excellent anti-corrosion performance.

- Strong and durable high-performance 4-blade aluminum propeller.
- Increased thrust for heavy loads and maneuverability.
- Shock-absorbing rubber bushing reduces vibrations and stress on the drivetrain.
- Four layers of paint ensure excellent anti-corrosion performance.

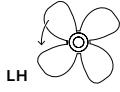

Ø x PITCH	 LH	 RH
14.75 x 15	3587519	3587517
14.5 x 17	3587521	3587520
14.25 x 19	3587523	3587522
14 x 21	3587525	3587524
14 x 23	–	3587526

Installation hardware, see next page.



SX Drives

3-blade stainless steel propeller

This performance provider enhances top speed, acceleration and durability versus a comparable aluminum propeller. The blade configuration and through-hub exhaust design are important factors for high efficiency and performance. This high strength stainless steel propeller really pushes the limits and makes it a perfect choice for high-power engines and fast boats.

- Enhances acceleration and top speed versus a comparable aluminum propeller.
- Excellent strength, durability and corrosion resistance.
- Shock-absorbing rubber bushing reduces vibrations and stress on the drivetrain.



Ø x PITCH	 LH	 RH
14.75 x 17	3860714	3862462
14.75 x 19	3860715	3860708
14.75 x 21	3860716	3860709
14.25 x 23	3860717	3860710

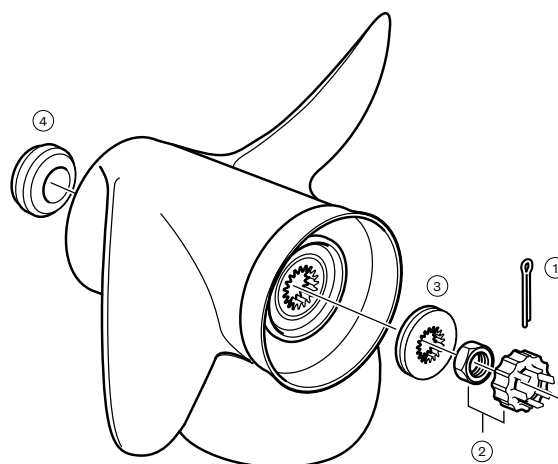

Installation hardware, 3 and 4-blade propellers for the SX drive

Pos	Part No	Item
1	3852056	Split pin
2	3850984	Propeller nut

Pos	Part No	Item
3	3852350	Spacer
4	3852020	Thrust washer

200, 250, 270, 275, 280, 285, 290, SP Drives



Aluminum propeller with long hub – High-speed series

The High-speed propeller with long hub is developed from the standard propeller and features more blade area. In a fast boat this not only means increased speed, but also that a heavily loaded boat will plane more quickly and enjoy better fuel economy. The increased blade area also provides faster and safer quayside maneuvering.

- Made of durable aluminum alloy developed to withstand salt water and cavitation damage.
- Painted with epoxy powder - extremely hard and resistant to abrasion.
- Long hub design with shock-absorbing rubber bushing.



Note! Always use long hub propeller for V6, V8, AQD40, AQAD31/40/41 engines.

Ø x PITCH		
	LH	RH
14 x 17	854977	854992
14 x 19	854978	854993
14 x 21	854979	854994
14 x 23	854980	854995
15 x 15	854981	854996
15 x 17	854982	854997
15 x 19	854983	854998
15 x 21	854984	854999
16 x 9	854985	—
16 x 13	854986	872000
16 x 15	854987	872001
16 x 17	854988	872002
16 x 19	854989	872003
16 x 21	854990	872004
16 x 23	854991	872005

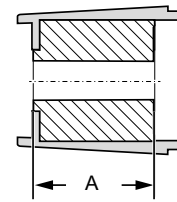

Long hub bushing
A = 93mm (3.661")

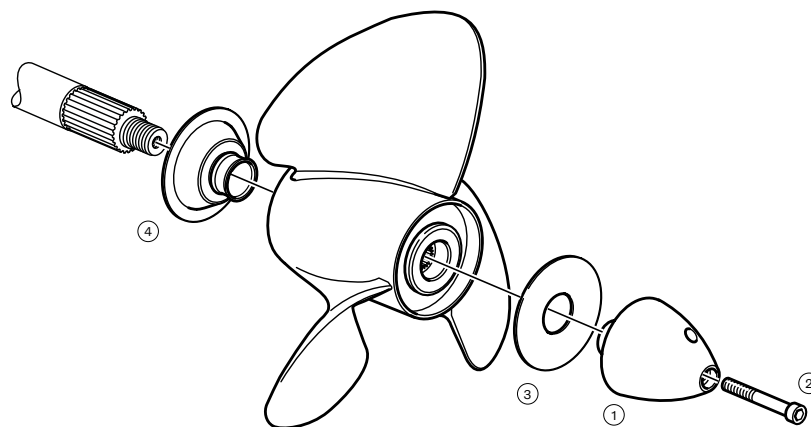

Installation hardware, long hub propeller

The propeller cone locking requires that the drive has an internally threaded propeller shaft intended for the locking screw (2), which was introduced on late production 270 and 280 drives but included as standard on newer drives. In some cases, older drives have been updated using retrofit drilling and threading.

Pos	Part No	Item
1	854045	Propeller cone
2	850889	Locking screw
3	850888	Plastic washer
4	832965	Line cutter/Thrust washer, 200

Pos	Part No	Item
4	839534	Line cutter/Thrust washer, 250, 270, 275
4	839423	Line cutter/Thrust washer, 280, 285, 290, SP-A
4	872082	Line cutter/Thrust washer, SP-A1, A2, C, C1, E
	873058	Tool

200, 250, 270, 275, 280, 285, 290, SP Drives



Aluminum propeller with short hub – High-speed and standard series

The High-speed propeller features more blade area than the standard propeller. In a fast boat this does not only mean increased speed, it also means that a heavily loaded boat will plane more quickly, enjoying better fuel economy and increased cruising speed. The increased blade area also provides faster and safer quayside maneuvering.

- Made of durable aluminum alloy developed to withstand salt water and cavitation damage.
- Painted with epoxy powder – extremely hard and resistant to abrasion.
- Short hub design with shock-absorbing rubber bushing.



Note! Always use long hub propeller for V6, V8, AQD40, AQAD31/40/41 engines.

Ø x PITCH		
	LH	RH
14 x 13	813284 STD	813285 STD
14 x 15	814626 HS	814631 HS
14 x 17	814627 HS	814632 HS
14 x 19	814628 HS	814633 HS
15 x 11	813296 STD	813297 STD
15 x 13	813316 STD	813317 STD
15 x 15	814611 HS	814615 HS
15 x 17	814612 HS	814616 HS

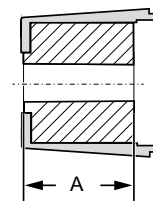

Short hub bushing
A = 78mm (3.071")

HS = High-speed propeller, short hub STD = Standard propeller, short hub

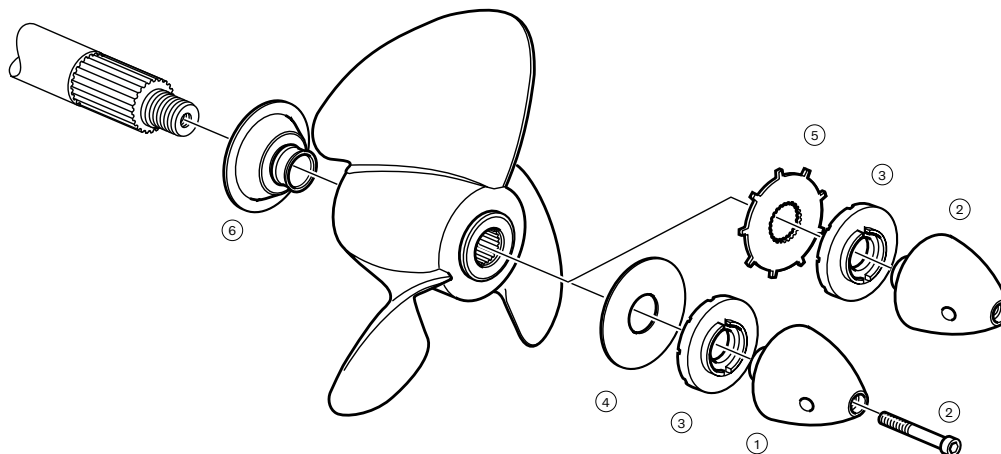

Installation hardware, short-hub propeller

The propeller cone is locked in different ways depending on the propeller shaft design. Use the locking screw (2) on newer drives that use an internally threaded propeller shaft. On drives without an internally threaded propeller shaft, use the tab washer (5).

Pos	Part No	Item
1	854045	Propeller cone
2	850889	Locking screw
3	854047	Spacer ring
4	850888	Plastic washer
5	897367	Tab washer

Pos	Part No	Item
6	832965	Line cutter/Thrust washer, 200
6	839534	Line cutter/Thrust washer, 250, 270, 275
6	839423	Line cutter/Thrust washer, 280, 285, 290, SP-A
6	872082	Line cutter/Thrust washer, SP-A1, A2, C, C1, E
	873058	Tool



100 Drives

Aluminum propeller – Standard and High-speed series

Standard and High-speed propellers are made from a special, durable aluminum alloy developed to withstand salt water and cavitation damage. Painted black with a special epoxy powder which is extremely hard and resistant to abrasion, the High-speed propeller features more blade area for increased performance.





Propellers for 100 drives with cylindrical shaft and locking pin

Ø x PITCH	LH 	RH 
13 x 13	813224 STD	813233 STD
13 x 15	839186 HS	
14 x 11	813227 STD	
14 x 13	813229 STD	
14 x 15	832992 STD	

HS = High-speed propeller STD = Standard propeller

Propellers for 100 drives with splines (13/16")

Ø x PITCH	LH 	RH 
14 x 11	804449	—

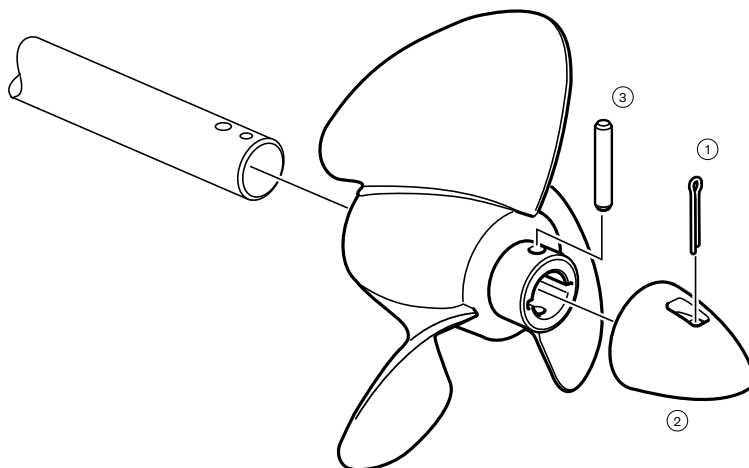

Installation hardware, 100 drives with cylindrical shaft and locking pin

Pos	Part No	Item
1	907881	Split pin
2	806660	Propeller cone

Pos	Part No	Item
3	806661	Shear pin



Corrosion protection

Anodes for drives and propellers

Get ready for the boating season and replace your old anodes before launching the boat into the water. Our aluminum anodes provide 30% higher corrosion protection capacity and up to 40% longer life span in salt water than compared with similar sized zinc anodes.

Our aluminum anodes can be used for all types of hull materials.

	Salt Water*	Brackish Water*	Fresh Water
Aluminum	✓	✓	—
Magnesium	—	—	✓

* Select zinc anode if aluminum anode is not provided for your product.

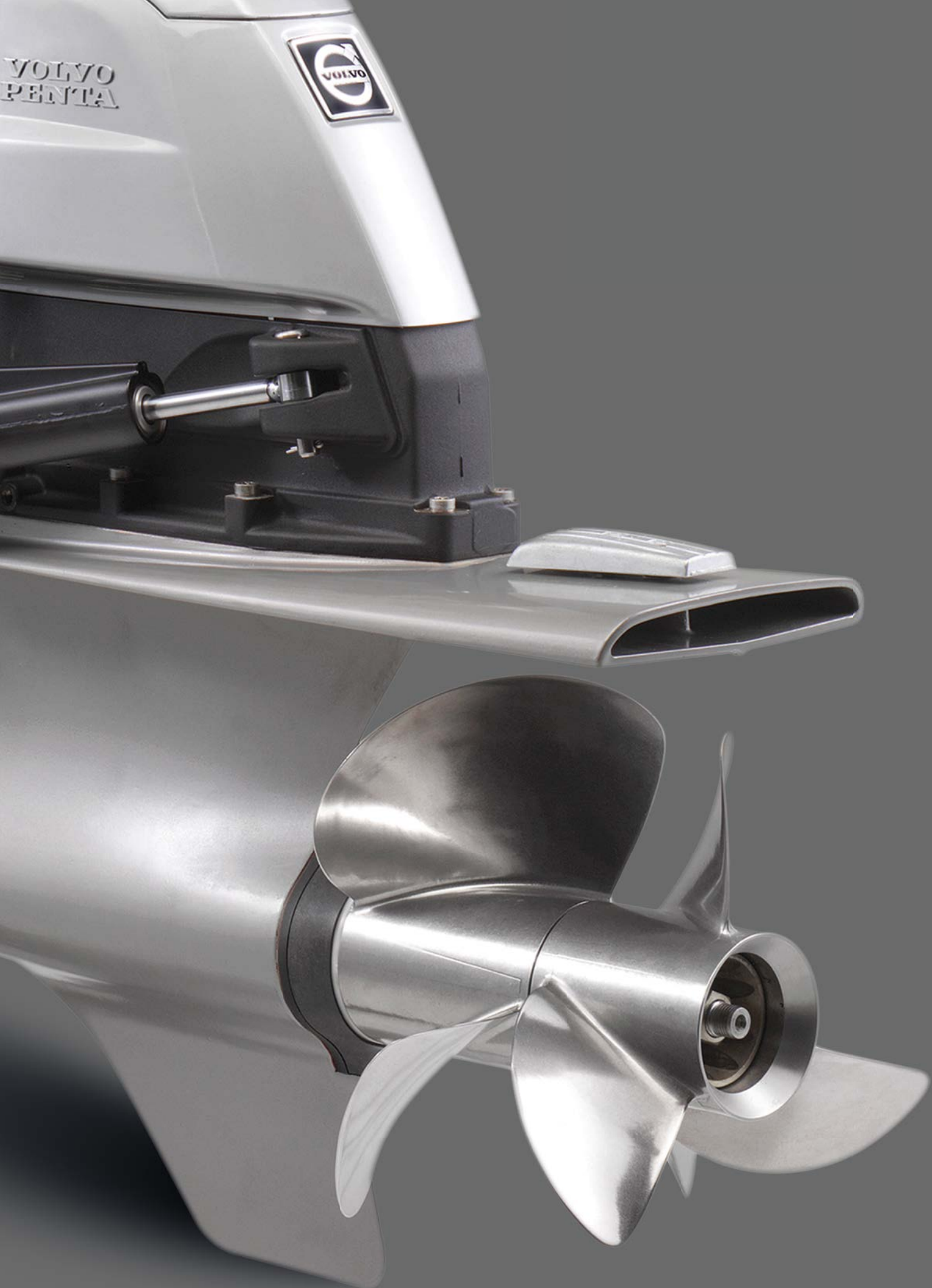

Duoprop propellers for Aquamatic Sterndrives

Two propellers. One superior thrust.

Launched in 1982, Volvo Penta showed the marine industry that twin counter-rotating propellers could produce unparalleled thrust, straight and true tracking along with faster acceleration - a completely new boating experience.

The duoprop propellers are designed to form a vital part of the driveline, providing highly efficient and predictable handling, together with excellent onboard comfort and fuel efficiency.

Furthermore, the optimal interaction between the front and rear propeller ensures maximum performance and fuel efficiency throughout the entire speed range, as well as smooth and comfortable running.

Every set of duoprop propellers is designed, tested and manufactured together to ensure not only a high top speed, but the best overall performance - all this while securing the service life of your drive.

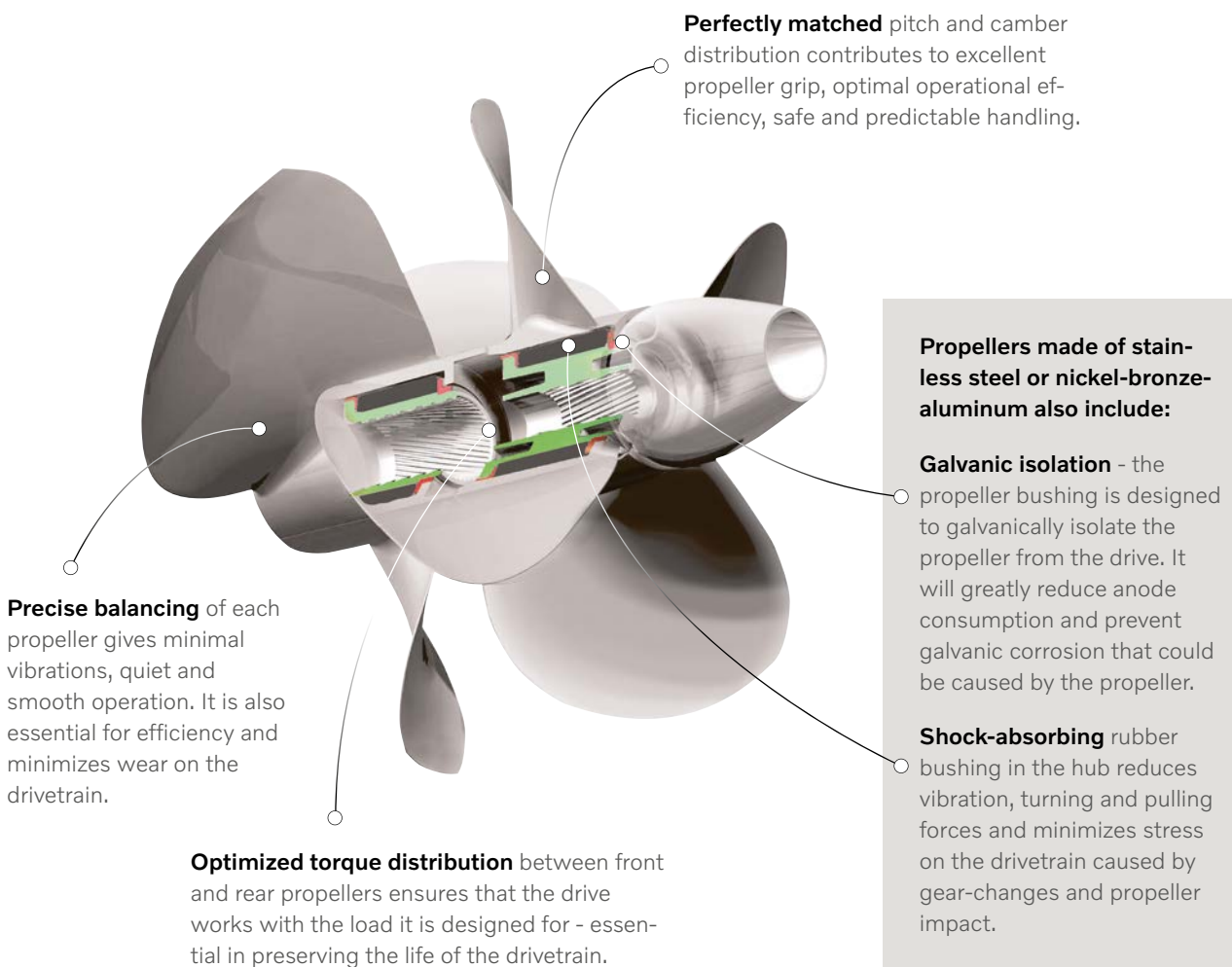

DPS Drives

Type I and IH – Aluminum Duoprop propellers

The patented blade geometry and large active propeller diameter provide optimal performance and fuel efficiency over the entire speed range as well as smooth running, excellent grip and maneuverability. Squeeze casting and special high strength aluminum alloy makes them stronger and more durable than traditional die-cast propellers. Four layers of paint ensure excellent anti-corrosion performance. Type I has straight splines, type IH has helical splines.



- Engineered to optimize performance, durability and comfort.
- Patented blade geometry, large active propeller diameter.
- Strong and durable high strength aluminum alloy.
- Three-blade front propeller and four-blade rear propeller.

Note! Always use type F or FH stainless steel propellers in 6-cylinder diesel engines or engines exceeding 240 hp or capable of speeds above 38 knots (45 mph). See next page.

Type I for DPS, DPS-A (straight splines)

DIM	Set	Front	Rear	DIM	Set	Front	Rear
I 2	21258482	21260642	21657162	I 7	21258487	21260647	21657167
I 3	21258483	21260643	21657163	I 8	21258488	21260648	21657168
I 4	21258484	21260644	21657164	I 9	21258489	21260649	21657169
I 5	21258485	21260645	21657165	I 10	21258490	21260650	21657170
I 6	21258486	21260646	21657166				

Installation hardware, see next page.

Type IH for DPS-B (helical/spiral splines)

DIM	Set	Front	Rear	DIM	Set	Front	Rear
IH 2	21661942	21661902	21661922	IH 7	21661947	21661907	21661927
IH 3	21661943	21661903	21661923	IH 8	21661948	21661908	21661928
IH 4	21661944	21661904	21661924	IH 9	21661949	21661909	21661929
IH 5	21661945	21661905	21661925	IH 10	21661950	21661910	21661930
IH 6	21661946	21661906	21661926				

Installation hardware, see next page.

Upgrade from type D propellers to type I propellers

To ensure the best performance for your boat, consult your Volvo Penta dealer for advice on the right propeller size for your drive and engine. **Note!** Do not mix Type D and I propellers. Always use propellers of the same type and size on the drive (or on both drives in twin installations).

Type D – Aluminum Duoprop propellers for DPS, DPS-A (straight splines)

Type D propeller sets are replaced by type I propeller sets. However, Type D propellers (front and rear) are sold individually as spare parts.

DIM	Front	Rear	DIM	Front	Rear
D 0	3851420	3851440	D 4	3851424	3851444
D 1	3851421	3851441	D 5	3856345	3856355
D 2	3851422	3851442	D 6	3856346	3856356
D 3	3851423	3851443	D 7	3856347	3856357

Installation hardware, see next page.



DPS Drives

Type F and FH – Stainless steel Duoprop propellers

This is the perfect upgrade for enhanced performance, strength and durability. It provides better acceleration and higher top speed due to greater strength and thinner blades - versus a comparable aluminum propeller. The high strength stainless steel adds excellent durability and corrosion resistance. Complete with shock-absorbing rubber bushing and galvanic isolation makes it perfectly matched for the DPS-drive and the ultimate choice for demanding boaters.



- Enhanced acceleration and top speed versus a comparable aluminum propeller.
- Excellent strength, durability and corrosion resistance.
- Galvanic isolation protects the drive from corrosion caused by the propellers.
- Shock-absorbing rubber bushing reduces vibrations and stress on the drivetrain.
- Three-blade front propeller and three-blade rear propeller.
- Type F has straight splines, type FH has helical (spiral) splines.

Type F for DPS, DPS-A (straight splines)

DIM	Set	Front	Rear	DIM	Set	Front	Rear
F 2	3857563	3857557	3857558	F 6	3851496	3851466	3851476
F 3	3857564	3857559	3857560	F 7	3851497	3851467	3851477
F 4	3851494	3851464	3851474	F 8	3851498	3851468	3851478
F 5	3851495	3851465	3851475	F 9	3851499	3851469	3851479

Type FH for DPS-B (helical/spiral splines)

DIM	Set	Front	Rear	DIM	Set	Front	Rear
FH 2	3885838	3885846	3885847	FH 6	3885842	3885854	3885855
FH 3	3885839	3885848	3885849	FH 7	3885843	3885857	3885859
FH 4	3885840	3885850	3885851	FH 8	3885844	3885860	3885861
FH 5	3885841	3885852	3885853	FH 9	3885845	3885862	3885863

Type D, I, IH

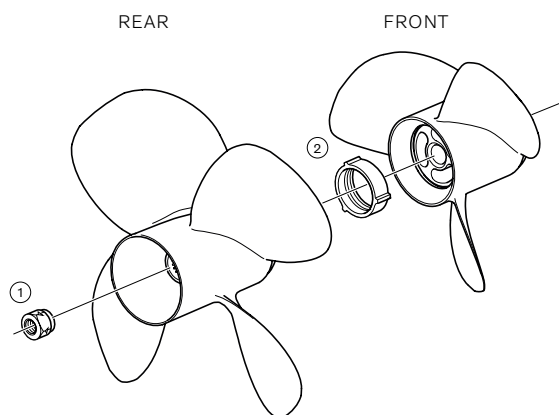

Type F, FH

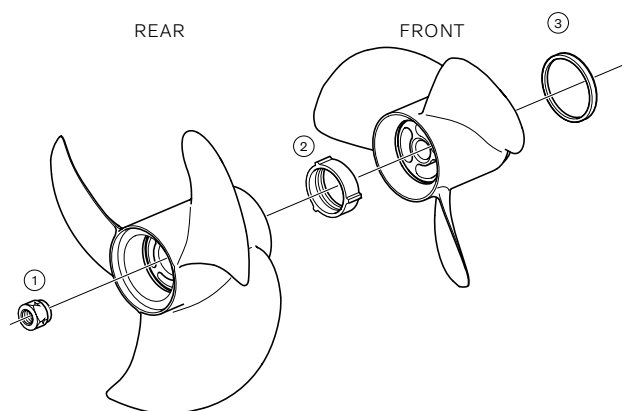

Installation hardware, type D, I, IH, F, FH

Pos	Part No	Item
1	21631162	Propeller nut, rear *)
2	3851569	Propeller nut, front
3	3851600	Ring (for F7, F8, F9, FH7, FH8, FH9)

*) Included in Type I propeller sets.

Pos	Part No	Item
	3862797	Tool, front
	3862808	Tool, rear
	3855516	Tool, front and rear propeller nut

DPH Drives

Type G – Nibral Duoprop propellers

The patented blade geometry provides optimal interaction between front and rear propellers for outstanding efficiency and smooth and comfortable operation. Complete with shock-absorbing rubber bushing and galvanic isolation makes it perfectly matched for the DPH-drive.



- Patented blade geometry, outstanding efficiency and comfort.
- Excellent durability, minimal marine growth.
- Extremely strong nibral (nickel-bronze-aluminum) alloy.
- Galvanic isolation protects the drive from corrosion caused by the propellers.
- Shock-absorbing rubber bushing reduces vibrations and stress on the drivetrain.
- Three-blade front propeller and four-blade rear propeller.

DIM	Set			DIM	Set		
	F	R	Front		F	R	Front
G2	—*		23795432	G7	—*		23795437
G3	—*		23795433	G8	—*		23795438
G4	—*		23795434	G9	—*		23795439
G5	—*		23795435	G10	—*		23795440
G6	—*		23795436				23795446
			23795442				23795447
			23795443				23795448
			23795444				23795449
			23795445				23795450

* Type G propeller sets are replaced by either type H propeller sets, or individually sold type G front and rear propellers.

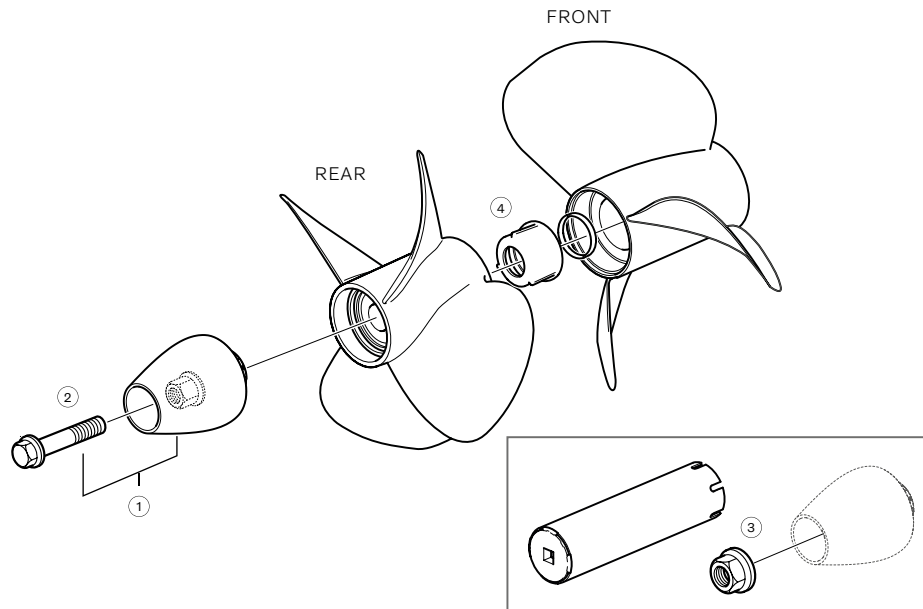

Installation hardware, type G

The propeller cone (1) has an integrated rear propeller nut and replaces previous propeller cone with separate rear propeller nut.

Pos	Part No	Item
1	21829326	Propeller cone kit*
2	991609	Lock bolt M12**
3	3863213	Propeller nut, rear***

Pos	Part No	Item
4	23952642	Propeller nut, front
	23161623	Tool for front propeller nut

* Propeller cone kit including propeller cone with integrated rear propeller nut and lock bolt (2).

** For newer DPH drives, DPH-D DPH-D1, with internal threaded propeller shaft intended for lock bolt (from SN 302029042).

*** For previous version DPH drives, DPH-A to DPH-C, propeller cone with separate rear propeller nut.

DPH and DPI Drives

Type H – Stainless steel Duoprop propellers

Designed to capture the tremendous torque from the new generation D4 and D6 engines. The patented blade geometry of the Type H propellers provides optimal interaction between front and rear propellers, for outstanding efficiency and smooth and comfortable operation. The large blade area provides maximum grip and maneuverability. Made of high strength stainless steel alloy for excellent strength and durability. Complete with shock absorbing rubber bushing and galvanic isolation makes it perfectly matched for the DPI and DPH-drive.



- Patented blade geometry, outstanding efficiency and comfort.
- Excellent durability, minimal marine growth.
- Made of highstrength stainless steel alloy.
- Galvanic isolation protects the drive from corrosion caused by the propellers.
- Shock-absorbing rubber bushing reduces vibrations and stress on the drivetrain.
- Three-blade front propeller and four-blade rear propeller.

DIM	Set			DIM	Set		
	F	R	Front		F	R	Front
H2	22754002	23623052	23623062	H7	22754007	23623057	23623067
H3	22754003	23623053	23623063	H8	22754008	23623058	23623068
H4	22754004	23623054	23623064	H9	22754009	23623059	23623069
H5	22754005	23623055	23623065	H10	22754010	23623060	23623070
H6	22754006	23623056	23623066				

Upgrade from type G propellers to type H propellers on DPH drives

The sizing remains the same, ie a G6 propeller corresponds to an H6 propeller. Should you need additional guidance on which propeller best suit your needs, contact your Volvo Penta dealer.

Note! The propeller cone must be replaced to fit type H propellers. See part number to the right. Do not mix Type G and H propellers. Always use propellers of the same type and size on the drive (or on both drives in twin installations).



Propeller cone kit for type H propellers. P/N 23000185

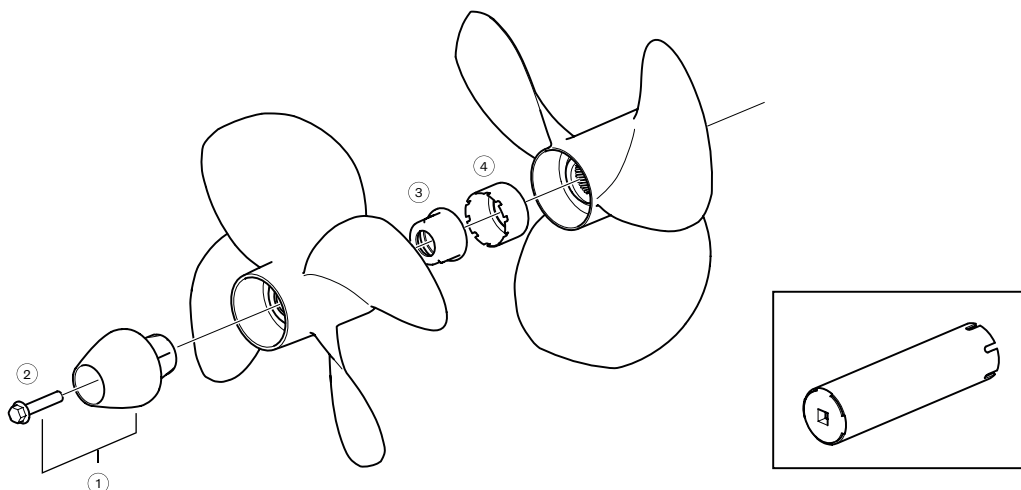

Installation hardware, type H

Pos	Part No	Item
1	23000185	Propeller cone kit, including lock bolt M12 *
2	991609	Lock bolt M12
3	23952642	Proeller nut, front

Pos	Part No	Item
4	23777877	Line cutter
	23161623	Tool for front propeller nut

* Propeller cone kit including propeller cone with integrated rear propeller nut and lock bolt (2).

FWD Drives

Type K – Stainless steel Duoprop propellers

Specifically designed for the Volvo Penta Forward Drive. These propellers are made of a strong and durable stainless steel to provide excellent acceleration and top speed. The patented bushing made of a naval brass reduces vibrations, stress on the drivetrain components and prevents corrosion by galvanically isolating the stainless steel propeller from the aluminum drive casting.



- Specifically designed for the Volvo Penta Forward Drive.
- Strong and durable stainless steel for excellent acceleration and top speed.
- Patented bushing reduces vibrations and stress on the drivetrain.
- Galvanic isolation protects the drive from corrosion caused by the propellers.
- Patented flow deflector minimizes pressure and wear on the propeller shaft seals.
- Three-blade front propeller and three-blade rear propeller.

DIM	Set			DIM	Set		
	Front	Front	Rear		Front	Front	Rear
K2	22417005	22414377	22414383	K5	22417008	22414380	22414386
K3	22417006	22414378	22414384	K6	22417009	22414381	22414387
K4	22417007	22414379	22414385	K7	22417010	22414382	22414388

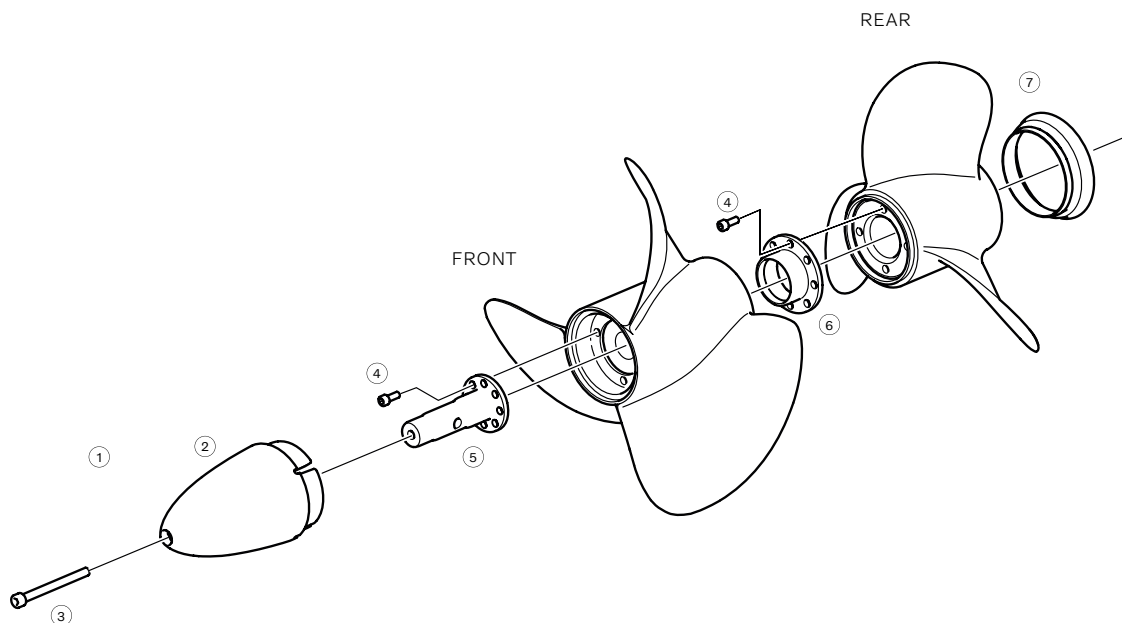

Installation hardware, type K

Pos	Part No	Item
1	22592621	Propeller hardware kit*
2	22413546	Propeller cone
3	60111646	Hex socket screw
4	963683	Hex socket screw

Pos	Part No	Item
5	22477740	Propeller nut, front
6	22477738	Propeller nut, rear
7	22436582	Flow deflector

* Propeller hardware kit including item 2, 3, 4, 5, 6.

DPR Drives

Type GR – Stainless steel Duoprop propellers

Developed for the DPR high-speed drive to maximize performance and efficiency. The high-performance blade geometry and great strength ensure maximum grip and maneuverability. Made of high strength stainless steel alloy for excellent durability and corrosion resistance. Shock-absorbing rubber bushing and galvanic isolation makes it perfectly matched for the DPR high-speed drive.



- High-performance blade geometry, great strength, thin blades.
- Excellent durability and corrosion resistance.
- Shock-absorbing rubber bushing reduces vibrations and stress on the drivetrain.
- Galvanic isolation protects the drive from corrosion caused by the propellers.
- Three-blade front propeller and three-blade rear propeller.

DIM	Set	Front	Rear
GR7	3863492	3863501	3863502
GR8	3863493	3863503	3863504
GR9	3863494	3863505	3863506

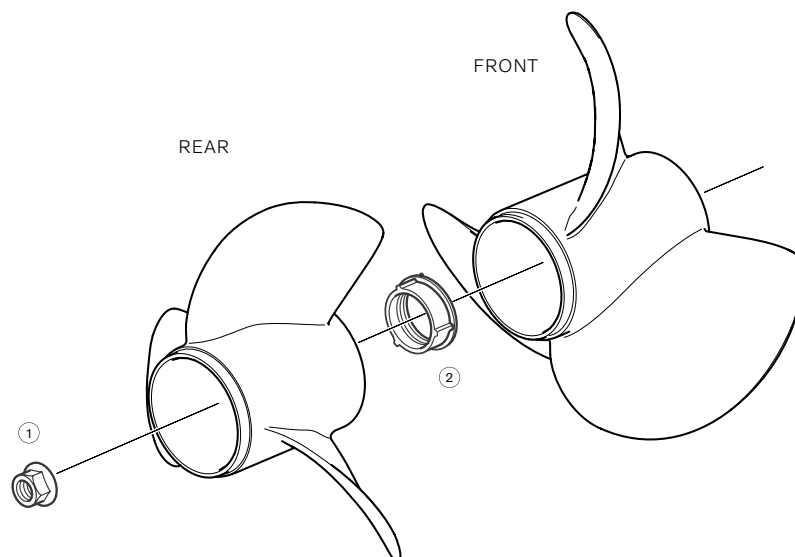

Installation hardware, type GR

Pos	Part No	Item
1	3863213	Propeller nut, rear
2	3863211	Propeller nut, front

Pos	Part No	Item
	21318669	Tool

280, 290, DP Drives

Type J – Aluminum Duoprop propellers

A completely modern aluminum propeller designed for our classic Duoprop drives. The patented blade geometry and large propeller diameter provides optimal efficiency as well as quiet and smooth operation. A special high strength aluminum alloy and squeeze casting process makes the propellers stronger and more durable than traditional die-cast propellers. Four layers of paint ensures excellent corrosion protection performance.

- Patented blade geometry and large active propeller diameter.
- Strong and durable high strength aluminum alloy.
- Excellent anti-corrosion performance.
- Three-blade front propeller and four-blade rear propeller.
- Replaces type A and type B propellers (see below for details).



Note! Always use type C stainless steel propellers in 6-cylinder diesel engines or engines exceeding 240 hp or capable of speeds above 38 knots (45 mph). See next page.

DIM	Set	F R	Front	Rear	DIM	Set	F R	Front	Rear
J 2	21924262		21924222	21924242	J 6	21924266		21924226	21924246
J 3	21924263		21924223	21924243	J 7	21924267		21924227	21924247
J 4	21924264		21924224	21924244	J 8	21924268		21924228	21924248
J 5	21924265		21924225	21924245	J 9	21924269		21924229	21924249
					J 10	21924270		21924230	21924250

Installation hardware, see next page.

Upgrade from type A or type B propellers to type J propellers

Type J propeller is designed to cover both type A and B propellers. J propeller sizes are not equally transferred from A or B sizes, ie: a A5 propeller not corresponds to a J5 propeller. To ensure the best performance for your boat, consult your Volvo Penta dealer for advice on the right propeller size for your drive and engine, providing the information of max boat speed and engine RPM to the dealer if possible.

Note! Do not mix Type A, B and J propellers. Always use propellers of the same type and size on the drive (or on both drives in twin installations).

Type A – Aluminum Duoprop propellers

Type A propeller sets are replaced by type J propeller sets. However, Type A propellers (front and rear) are sold individually as spare parts. However, complete sets of A0 and A1 are available.

DIM	Set	F R	Front	Rear	DIM	Front	Rear
A 0	872270		872259	872264	A 6	854779	854789
A 1	854764		854774	854784	A 7	854780	854790
A 2			854775	854785	A 8	854781	854791
A 3			854776	854786	A 9	854782	854792
A 4			854777	854787	A 10	854783	854793
A 5			854778	854788			

Installation hardware, see next page.



Type B – Aluminum Duoprop propellers

Type B propeller sets are replaced by type J propeller sets. However, Type B propellers (front and rear) are sold individually as spare parts.

DIM	Front	Rear	DIM	Front	Rear
B 1	854822	854830	B 5	854826	854834
B 2	854823	854831	B 6	854827	854835
B 3	854824	854832	B 7	854828	854836
B 4	854825	854833	B 8	854829	854837

Installation hardware, see next page.



280, 290, DP Drives

Type C – Stainless steel Duoprop propellers

This is the perfect upgrade for enhanced performance, strength and durability. It provides better acceleration and higher top speed through greater strength and thinner blades versus a comparable aluminum propeller. The stainless steel material makes the propellers durable and highly resistant to cavitation, damage and corrosion. Complete with shock-absorbing rubber bushing and galvanic isolation in the hub.



- Enhanced acceleration and top speed versus a comparable aluminum propeller.
- Excellent strength, durability and corrosion resistance.
- Shock-absorbing rubber bushing reduces vibrations and stress on the drivetrain.
- Galvanic isolation protects the drive from corrosion caused by the propellers.
- Three-blade front propeller and three-blade rear propeller.

DIM				DIM			
	Set	Front	Rear		Set	Front	Rear
C 2	3588222	3587864	3587870	C 5	3588225	3587867	3587873
C 3	3588223	3587865	3587871	C 6	3588226	3587868	3587874
C 4	3588224	3587866	3587872	C 7	3588227	3587869	3587875

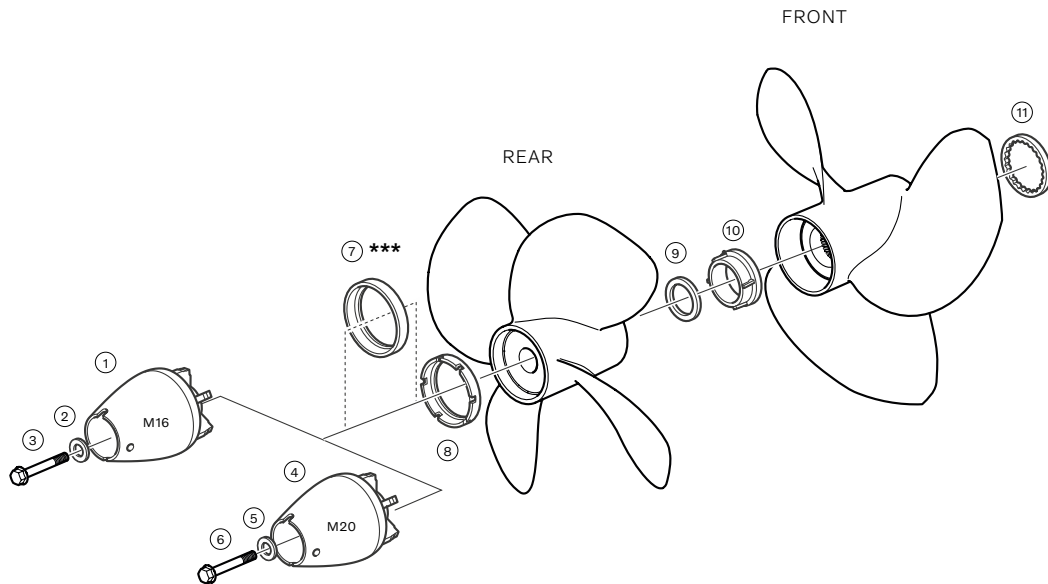

Installation hardware, type A, B, C, J

Pos	Part No	Item
1	872614	Propeller cone kit M16*
2	941670	Washer M8
3	872545	Lock screw M8
4	872549	Propeller cone kit M20**
5	943194	Washer M12
6	872546	Lock screw M12
7	853676	Spacer ring for propeller cone ***

Pos	Part No	Item
8	854294	Plastic washer
9	3858458	Thrust ring
10	3851334	Propeller nut
11	3858457	Thrust ring
	854668	Tool kit, for propeller cone kit M16
	873058	Tool kit, for propeller cone kit M20

* Propeller cone kit M16 including item 1, 2, 3, 7, 8.

** Propeller cone kit M20 including item 4, 5, 6, 7, 8.

*** Spacer ring for propeller cone only to be used with type A propellers.



Propellers for Volvo Penta IPS

Faster, further, cleaner and quieter

When Volvo Penta launched the revolutionary IPS (Inboard Performance System) we set a completely new standard in efficiency, comfort and maneuverability. By turning the propellers around to a forward-facing position, the world of boating changed forever.

These twin counter-rotating propellers form an important part of the hydro-dynamically designed propulsion unit - pulling the boat through the water rather than pushing it.

Furthermore, optimal interaction between the front and rear propeller ensures maximum performance and fuel efficiency throughout the entire speed range, as well as smooth and comfortable running.

The state-of-the-art IPS propellers are developed, tested and manufactured with the highest precision. Not only do they contribute to outstanding performance and fuel efficiency, but also handling and onboard comfort - all this while securing the service life of your drive.

Precise balancing gives minimal vibrations, quiet and comfortable operation. It is also essential for efficiency and minimizes wear on the drivetrain.

Fully CNC machining ensures exact tolerances and perfect geometry of each propeller, which results in total precision and outstanding performance.

Optimal interaction between the front and rear propeller ensures maximum performance and fuel efficiency throughout the entire speed range, as well as smooth and comfortable running.

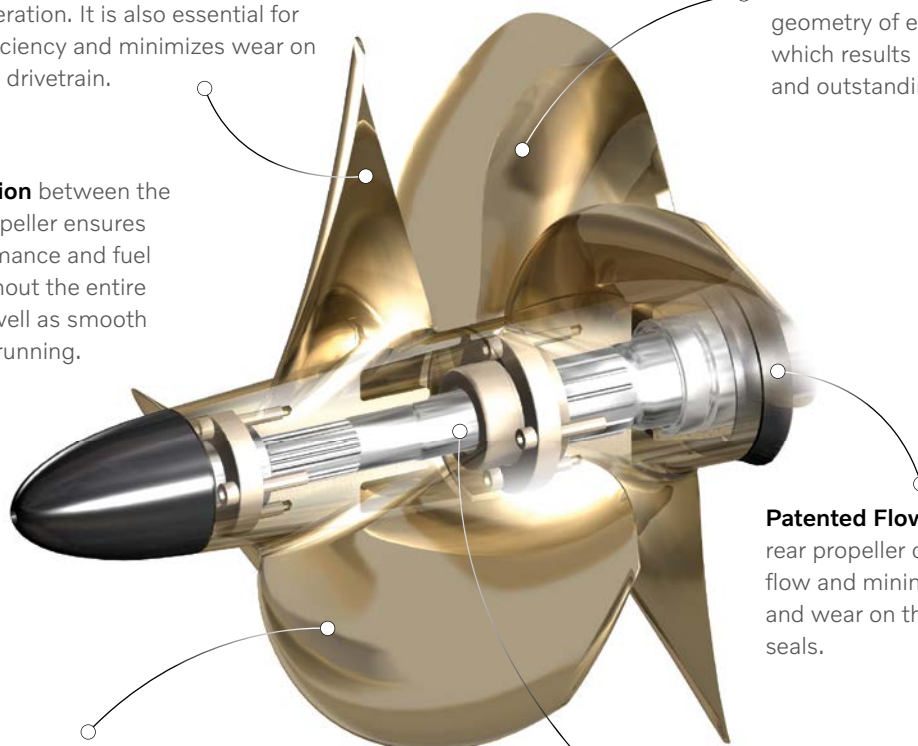

Patented Flow deflector at the rear propeller controls the water flow and minimizes pressure and wear on the propeller shaft seals.

Extremely strong and specially developed nibral (nickel-bronze-aluminum) alloy ensures minimum growth, excellent durability and corrosion resistance.

Optimized torque distribution between front and rear propellers ensures that the drive works with the load it is designed for - essential in preserving the life of the drivetrain.

IPS 1 and IPS 10

Type T/TS – Nibral propellers

Specifically developed for IPS with D4 and D6 engines to give outstanding efficiency, onboard comfort and maneuverability.

- Extremely strong and specially developed nibral (nickel-bronze-aluminum) alloy.
- Minimum growth, excellent durability and corrosion resistance.
- Patented flow deflector minimizes pressure and wear on propeller shaft seals.
- Three-blade front propeller and four-blade rear propeller.



DIM	Set	Front	Rear	DIM	Set	Front	Rear
TS3	23442963	24044393	24044443	T4	23442954	24044384	24044434
TS4	23442964	24044394	24044444	T5	23442955	24044385	24044435
TS5	23442965	24044395	24044445	T6	23442956	24044386	24044436
TS6	23442966	24044396	24044446	T7	23442957	24044387	24044437
T2	23442952	24044382	24044432	T8	23442958	24044388	24044438
T3	23442953	24044383	24044433				

The type T/TS series covers applications from semi-planing boats with moderate top speeds to planing boats with high top speeds.

TS3	TS4	TS5	TS6	T2	T3	T4	T5	T6	T7	T8
Moderate top speed						High top speed				

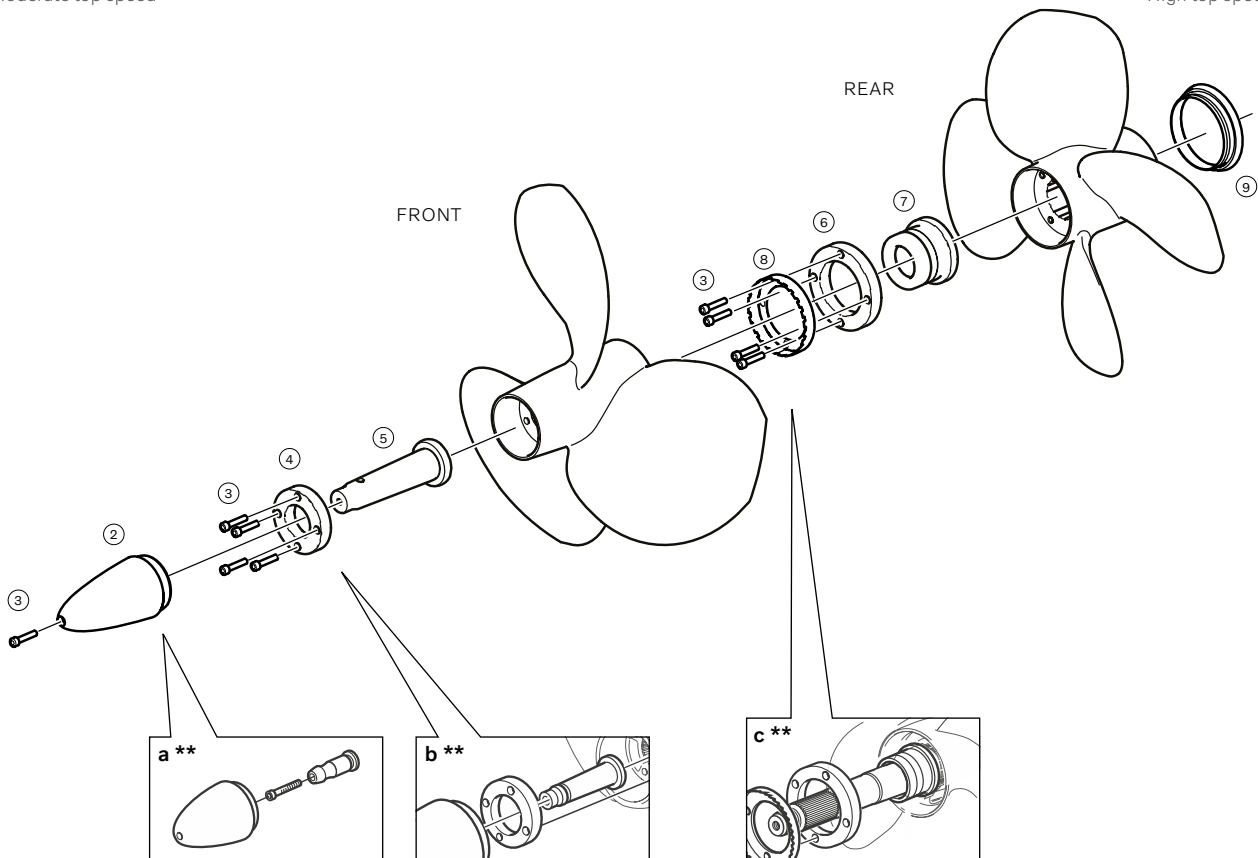

Installation hardware, type T/TS

Pos	Part No	Item
1	23779449	Propeller cone kit*
2	22072153	Propeller cone
3	963699	Hex socket screw
4	3861088	Lock plate**
5	21293480	Propeller nut**

Pos	Part No	Item
6	3861209	Lock ring***
7	3861087	Lock nut***
8	23062729	Line cutter
9	3862454	Flow deflector
	23284156	Locking fluid (10 ml)

* Propeller cone kit consist of Pos 2, Pos 3, Pos 4, Pos 5, Pos 6, Pos 7, lubricating grease and a tool.

** IPS1 earlier propeller nut front is replaced by Lock plate(4) and propeller nut(5).

*** IPS1 earlier propeller nut rear is replaced by Lock ring(6) and lock nut(7)

IPS 15

Type N/NS – Nibral propellers

Specifically developed for IPS with D8 engines to give outstanding efficiency, onboard comfort and maneuverability.

- Extremely strong and specially developed nibral (nickel-bronze-aluminum) alloy.
- Minimum growth, excellent durability and corrosion resistance.
- Patented flow deflector minimizes pressure and wear on propeller shaft seals.
- Three-blade front propeller and four-blade rear propeller.



Note! The type N/NS propeller is type approved by DNV for D8 IPS600, IPS650, IPS700

DIM			DIM		
Set	Front	Rear	Set	Front	Rear
NS4	21916044	21915974	N4	21808224	21808194
NS5	21916045	21915975	N5	21808225	21808195
N1	21808221	21808191	N6	21808226	21808196
N2	21808222	21808192	N7	21808227	21808197
N3	21808223	21808193			21808217

The type N/NS series covers applications from semi-planing boats with moderate top speeds to planing boats with high top speeds.

NS4	NS5	N1	N2	N3	N4	N5	N6	N7
Moderate top speed					High top speed			

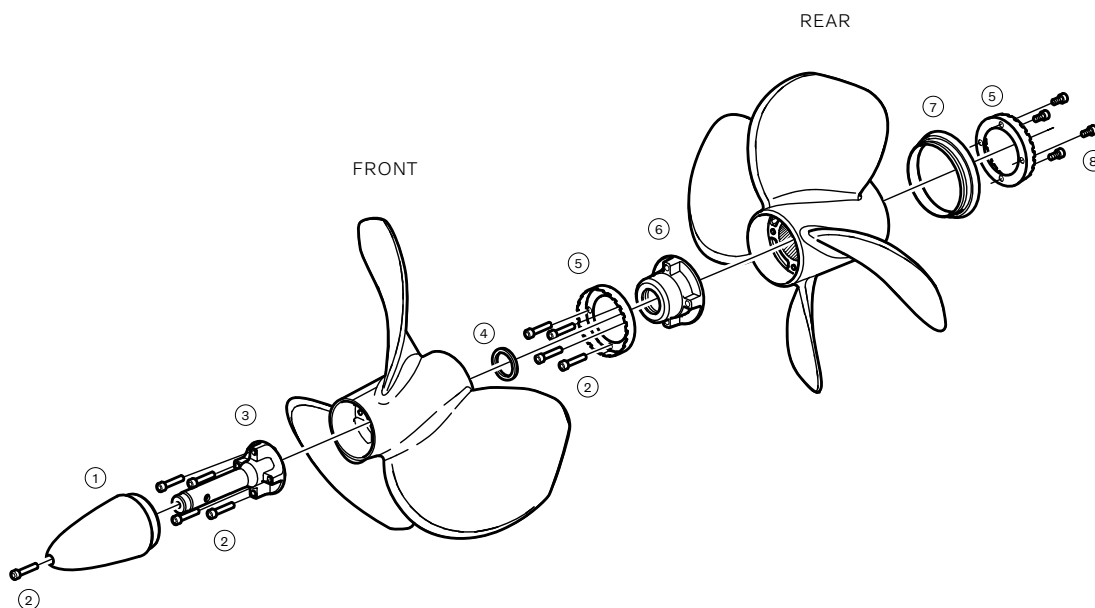

Installation hardware, type N/NS

Pos	Part No	Item
1	21815881	Propeller cone
2	963699	Hex socket screw
3	21815875	Propeller nut, front
4	21816205	Felt washer

Pos	Part No	Item
5	21913550	Line cutter
6	21815872	Propeller nut, rear
7	21808200	Flow deflector
8	963696	Hex socket screw
	23284156	Locking fluid (10 ml)

IPS 2 and IPS 20

Type P/PS – Nibral propellers

Specifically developed for IPS with D11 engines to give outstanding efficiency, onboard comfort and maneuverability.

- Extremely strong and specially developed nibral (nickel-bronze-aluminum) alloy.
- Minimum growth, excellent durability and corrosion resistance.
- Patented flow deflector minimizes pressure and wear on propeller shaft seals.
- Three-blade front propeller and four-blade rear propeller.



Note! The type P/PS propeller is type approved by DNV for D11 IPS650, IPS800

DIM			DIM			
Set	Front	Rear	Set	Front	Rear	
PS4	23427144	23427154	P4	23427064	23427074	23427084
PS5	23427145	23427155	P5	23427065	23427075	23427085
P1	23427061	23427071	P6	23427066	23427076	23427086
P2	23427062	23427072	P7	23427067	23427077	23427087
P3	23427063	23427073	P8	3843974	–	–

The type P/PS series covers applications from semi-planing boats with moderate top speeds to planing boats with high top speeds.

PS4	PS5	P1	P2	P3	P4	P5	P6	P7	P8
Moderate top speed						High top speed			

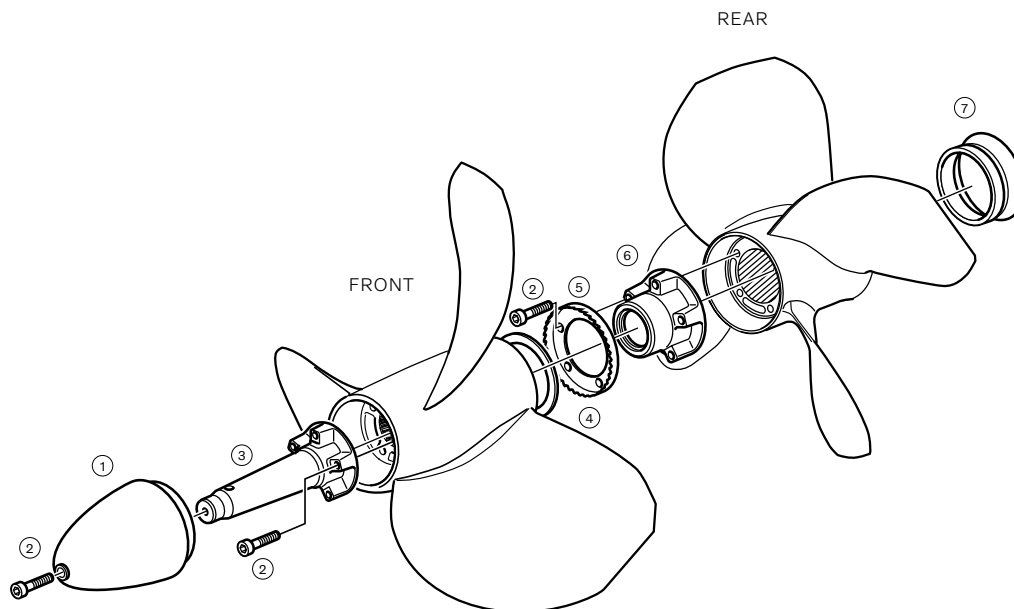

Installation hardware, type P/PS

Pos	Part No	Item
1	21154200	Propeller cone
2	963699	Hex socket screw
3	21154206	Propeller nut, front
4	3593639	Felt washer

Pos	Part No	Item
5	21686494	Line cutter
6	21154277	Propeller nut, rear
7	3843992	Flow deflector
	85145750	Locking fluid (10 ml)

IPS 3 and IPS 30

Type Q/QS – Nibral propellers

Specifically developed for IPS with D13 engines to give outstanding efficiency, onboard comfort and maneuverability.

- Extremely strong and specially developed nibral (nickel-bronze-aluminum) alloy.
- Minimum growth, excellent durability and corrosion resistance.
- Patented flow deflector minimizes pressure and wear on propeller shaft seals.
- Three-blade front propeller and four-blade rear propeller.



Note! The type Q/QS propeller is type approved by DNV for D13 IPS900, IPS1050, IPS1200 and IPS1350

DIM	Set	Front	Rear	DIM	Set	Front	Rear
QS4	21821364	21821254	21821264	Q4	21433624	21433604	21433614
QS5	21821365	21821255	21821265	Q5	21433625	21433605	21433615
Q1	21433621	21433601	21433611	Q6	21433626	21433606	21433616
Q2	21433622	21433602	21433612	Q7	21433627	21433607	21433617
Q3	21433623	21433603	21433613	Q8	21433628	21433608	21433618

The type Q/QS series covers applications from semi-planing boats with moderate top speeds to planing boats with high top speeds.

QS4	QS5	Q1	Q2	Q3	Q4	Q5	Q6	Q7	Q8
Moderate top speed					High top speed				

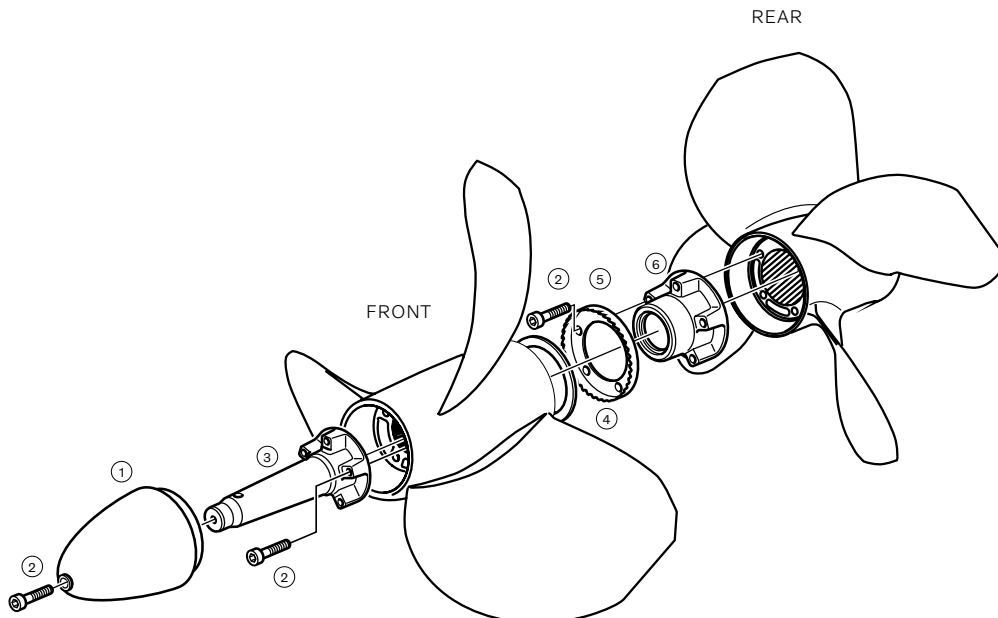

Installation hardware, type Q/QS

Pos	Part No	Item
1	40005165	Propeller cone
2	963699	Hex socket screw
3	40005157	Propeller nut, front
4	21235219	Felt washer

Pos	Part No	Item
5	21686496	Line cutter
6	40005161	Propeller nut, rear
	85145750	Locking fluid (10 ml)

IPS 3 and IPS 30

Type QE – Nibral propellers

The QE propeller is a variant of the standard high performance Q propeller, featuring thicker blades and a slightly larger blade area. This adds strength and overall robustness, but will reduce efficiency and top speed. QE propellers could be a good choice for marine commercial vessels when operating in an area of temporary debris and flotsam, such as crushed ice and other floating objects that can damage the propeller.

When considering changing to the QE propeller, please consult your local dealer or local Volvo Penta Sales Application Engineer for size guidance and speed calculations.

Note! The type QE propeller is approved for D13 IPS900, IPS1050 & IPS1200.



DIM	Set	Front	Rear	DIM	Set	Front	Rear
QE1	22059721	22059611	22059631	QE3	22059723	22059613	22059633
QE2	22059722	22059612	22059632	QE4	22059724	22059614	22059634

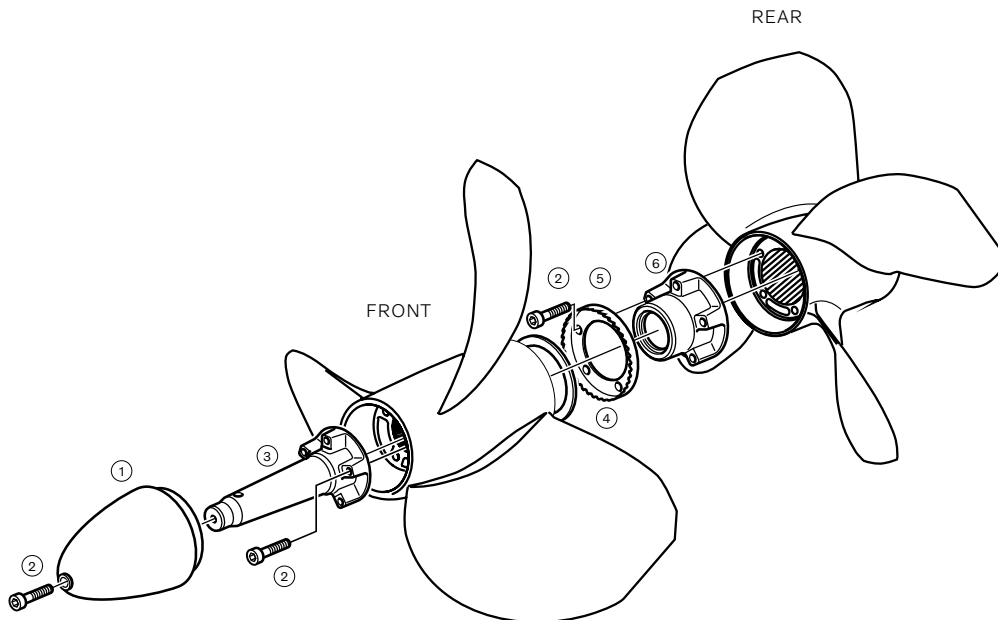

Installation hardware, type QE

Pos	Part No	Item
1	40005165	Propeller cone
2	963699	Hex socket screw
3	40005157	Propeller nut, front
4	21235219	Felt washer

Pos	Part No	Item
5	21686496	Line cutter
6	40005161	Propeller nut, rear
	85145750	Locking fluid (10 ml)



Corrosion protection

Multi-purpose premium Grease for propeller component

Volvo Penta water-resistant grease is developed to provide excellent adhesion, water resistance and load-carrying properties, as well as long-term protection against corrosion.

The multi-purpose premium grease is highly recommended for greasing propeller shafts, folding propellers and all other propeller components.

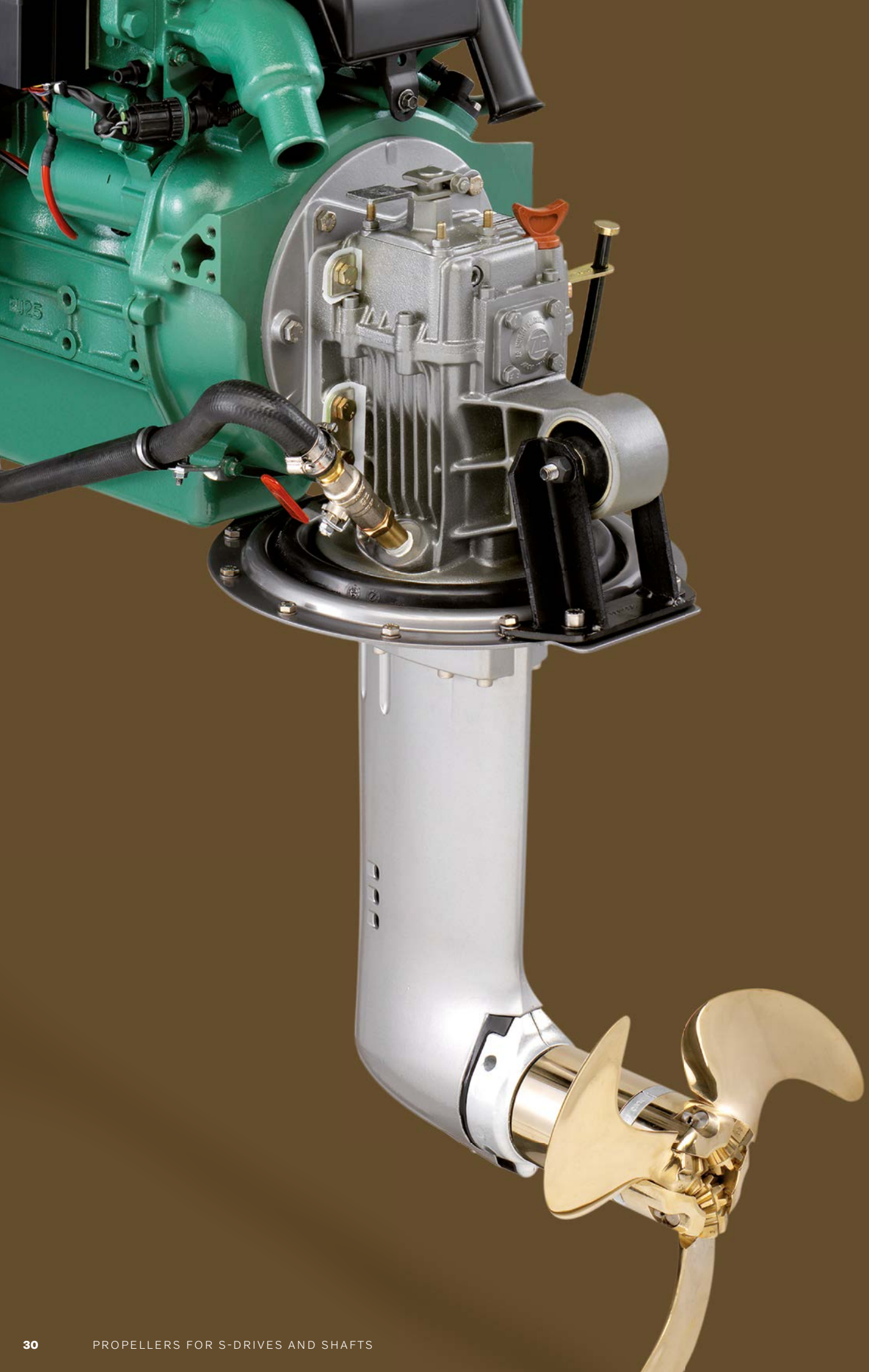

Folding propellers for S-drive and shaft

Sailing without compromise

Volvo Penta folding propellers offer the best of both worlds - minimal drag while sailing combined with the high thrust of a fixed propeller while motoring - even in reverse.

The unique and patented design always ensures quick and safe opening of the blades for excellent close-quarter maneuverability and minimal stopping distance.

Whether you choose a 2, 3 or 4-blade model, the swept blade design (high-skew) provides extremely smooth running - virtually eliminating noise and vibrations for excellent comfort during motoring. And what's more, the reduced drag under sail increases speed by up to 1.5 knots compared with a fixed propeller. Put all this together and you greatly increase your sailing pleasure.

Powerful thrust, even in reverse thanks to the highly-efficient and patented blade geometry. This means excellent close-quarter maneuverability and short stopping distance.

Excellent durability and corrosion resistance thanks to specially developed nibral (nickel-bronze-aluminum) alloy.

High-skew blade design reduces pressure pulses to ensure smooth, low-noise operation with minimal vibrations.

The reliable and consistent conical teeth mechanism ensures synchronized opening and closing of the blades.

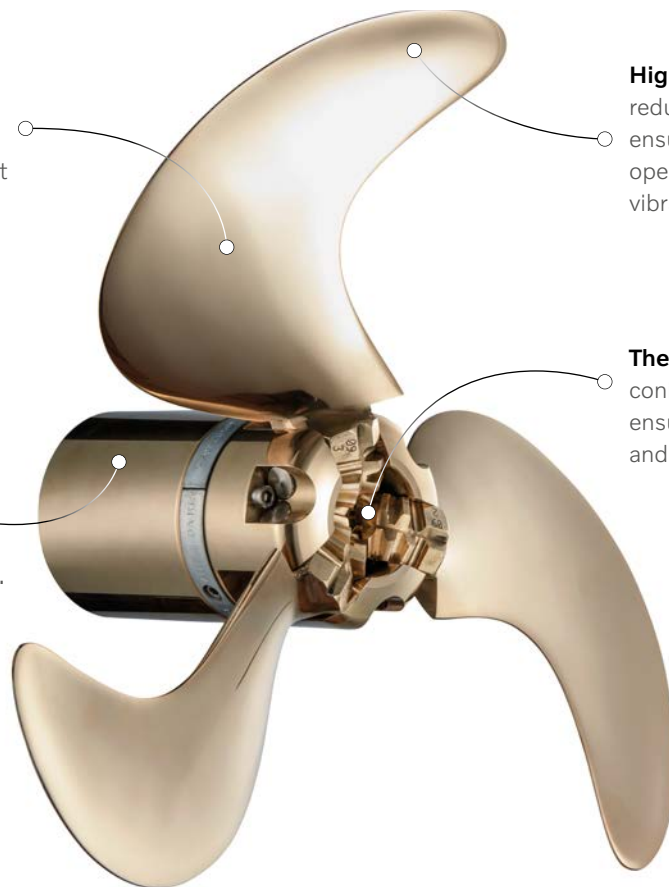

Folding propellers for S-drive and shaft



Minimizing drag and increasing speed

Volvo Penta folding propellers improve the performance of your boat minimizing drag and increasing speed - up to 1.5 knots under sail, compared with a fixed propeller. In addition, the sleek profile also reduces the risk of snagging ropes, nets and debris when sailing.

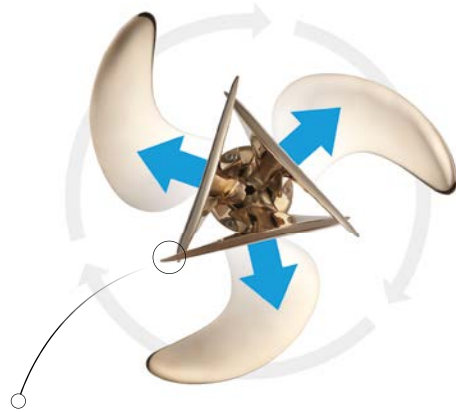

Instant and powerful response - even in reverse

The patented design, with protruding blade tips ensures an instant opening action when the reverse gear is engaged. As soon as the propeller begins to rotate, mounting water pressure on the blade tips forces the blades to open. Centrifugal force then finalizes the opening action.



Rubber bushing and galvanic isolation

Hubs for saildrive propellers include a shock-absorbing rubber bushing to minimize stress on the drivetrain caused by gear changes. In addition, the bushing is designed to galvanically isolate the propeller from the saildrive - preventing galvanic corrosion caused by the propeller.

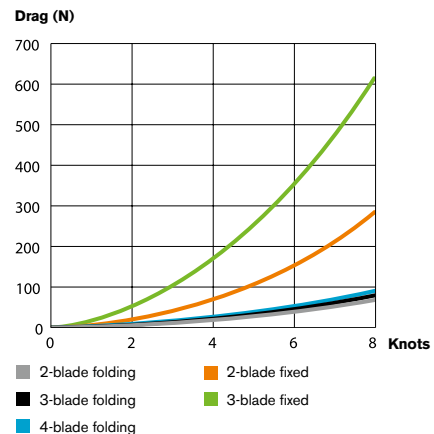

The test was carried out by SSPA Maritime Consulting. All propellers were mounted on a Saildrive propulsion system.

Difference in propeller drag

The graph shows the difference in propeller drag and how rapidly the drag increases with fixed propellers and higher speed. At 8 knots for example, a 3-blade fixed propeller produces more than six times the drag of a 3-blade folding propeller. This means a typical journey across the English Channel can be reduced by up to 4 hours thanks to lower drag.

S-drive and shaft

2-blade folding propeller for 5–40 hp



Designed for engines from 5 up to 40 hp. Available in multiple sizes and pitches for both S-drives and shafts. Made of extremely strong and durable nibral (nickel-bronze-aluminum) alloy.

- Powerful thrust even in reverse thanks to patented blade geometry
- Smooth, low-noise operation with minimal vibrations
- Safe opening with quick response in both forward and reverse
- Rubber bushing and galvanic isolation (hubs for S-drives)

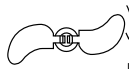

Note! For a complete propeller, order one blade kit and one hub kit. Propeller size has to be calculated to match engine and gear ratio, please contact your Volvo Penta dealer.

Blade kits

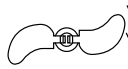
S-Drive & Shaft		Shaft		S-Drive & Shaft		Shaft	
Ø x PITCH	 LH	 RH	Ø x PITCH	 LH	 RH		
14 x 7	21629132	21629136	16 x 11	21629182		21629186	
14 x 8	21629140	21629144	17 x 11	21629190		21629194	
15 x 8	21629147	21629152	17 x 12	21629198		21629201	
15 x 10	21629158	21629167	18 x 12	21629205		21629211	
16 x 10	21629173	21629177	19 x 13	21629214		21629218	

Blade kit includes: Blades, hex key for locking screw (pos 11), lubricant grease and installation instruction.

Hub kits

Hub kit for S-drives		Hub kit for shafts	
110S, 120S, MS25S, 130S, 150S	21630720	Pre-drilled hub*	21630725
Hub kit for metric standard shaft (1:10 taper)		Hub kit for SAE standard shaft (1:16 taper)	
25 mm shaft (key 6 mm)	21630721	1" shaft (key 5/16")	21630723
30 mm shaft (Key 8 mm)	21630722	1 1/4" shaft (key 5/16")	21630724

Hub kit includes: Anodes, locking fluid and installation hardware listed in the table below. Nut and key are excluded from hub kit.

* Hub pre-drilled with 8 mm hole. Require final machining to the required shaft diameter and taper. Suitable for shafts up to 31,75 mm (1 1/4").

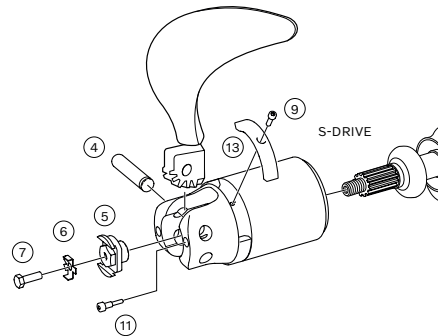
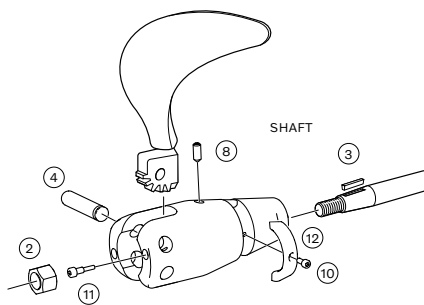

Installation hardware, 2-blade folding propeller

Pos	Part No	Qty	Item
	873475	1	Tab washer, M16
	873488	1	Tab washer, M20
2	873473	1	Nut, prop shaft, M16
2	873486	1	Nut, prop shaft, M20
3	873474	1	Key, prop shaft, Ø25mm
3	873487	1	Key, prop shaft, Ø30mm
4	21626924	2	Shaft ^{1,2)}
5	3584466	1	Propeller nut ¹⁾
6	3851994	1	Lock washer ¹⁾

Pos	Part No	Qty	Item
7	946730	1	Hexagon screw ¹⁾
8	94800	2	Screw ²⁾
9	963677	2	Hex. socket screw ¹⁾
10	963675	2	Hex. socket screw ²⁾
11	3595221	2	Lock screw ^{1,2)}
12		2	Anode ^{2,3)}
13		3	Anode ^{1,3)}
	23284156	1	Locking fluid (10 ml) ^{1,2)}

1) Included in hub kit for S-drive. 2) Included in hub kit for shaft. 3) For part number, see chapter "Related product".

S-drive and shaft

3-blade folding propeller for 20–60 hp





Designed for engines from 20 up to 60 hp. Available in multiple sizes and pitches for both S-drives and shafts. Made of extremely strong and durable nibral (nickel-bronze-aluminum) alloy.



- Powerful thrust even in reverse thanks to patented blade geometry
- Smooth, low-noise operation with minimal vibrations
- Safe opening with quick response in both forward and reverse
- Rubber bushing and galvanic isolation (hubs for S-drives)

Note! For a complete propeller, order one blade kit and one hub kit. Propeller size has to be calculated to match engine and gear ratio, please contact your Volvo Penta dealer.

Blade kits

S-Drive & Shaft		Shaft	S-Drive & Shaft		Shaft
Ø x PITCH	 LH	 RH	Ø x PITCH	 LH	 RH
14 x 7	—	3583409	17 x 12	3583388	3583417
14 x 8	—	3583410	18 x 12	3583389	3583418
14 x 9	3583382	3583411	18 x 13	3583390	3583419
15 x 9	3583383	3583412	18 x 14	3583391	3583420
15 x 10	3583384	3583413	18 x 15	3583392	3583421
16 x 10	3583385	3583414	18 x 16	3584031	3583422
16 x 11	3583386	3583415	19 x 16	3583393	3583423
17 x 11	3583387	3583416			

Blade kit includes: Blades, hex key for locking screw (pos 10), lubricant grease and installation instruction.

Hub kits

Hub kit for S-drives		Hub kit for shafts	
110S, 120S, MS25S, 130S, 150S	3858955	Pre-drilled hub*	3583428
Hub kit for metric standard shaft (1:10 taper)		Hub kit for SAE standard shaft (1:16 taper)	
25 mm shaft (key 6 mm)	3583424	1" shaft (key 1/4")	3583426
30 mm shaft (Key 8 mm)	3583425	1 1/4" shaft (key 5/16")	3583427

Hub kit includes: Anodes, locking fluid and installation hardware listed in the table below. Nut and key are excluded from hub kit.

* Hub pre-drilled with 8 mm hole. Require final machining to the required shaft diameter and taper. Suitable for shafts up to 31,75 mm (1 1/4").

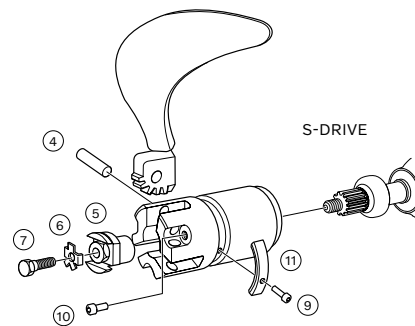
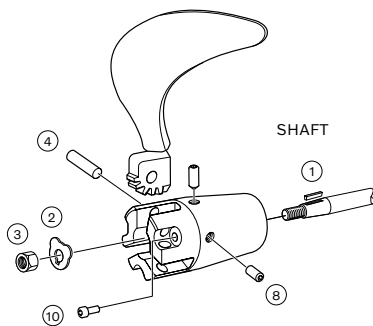

Installation hardware, 3-blade folding propeller

Pos	Part No	Qty	Item
1	873474	1	Key, prop shaft, Ø25mm
1	873487	1	Key, prop shaft, Ø30mm
2	873475	1	Tab washer, M16
2	873488	1	Tab washer, M20
3	873473	1	Nut, prop shaft, M16
3	873486	1	Nut, prop shaft, M20
4	3581243	3	Shaft ^{1,2)}
5	3584466	1	Propeller nut ¹⁾

Pos	Part No	Qty	Item
6	3851994	1	Lock washer ¹⁾
7	946730	1	Hexagon screw ¹⁾
8	948000	2	Screw ²⁾
9	963677	3	Hex. socket screw ¹⁾
10	963695	3	Hex. socket screw ^{1,2)}
11		3	Anode ^{1,3)}
	23284156	1	Locking fluid (10 ml) ^{1,2)}

1) Included in hub kit for S-drive. 2) Included in hub kit for shaft. 3) For part number, see chapter "Related product".

S-drive and shaft

4-blade folding propeller for 55–120 hp





Designed for engines from 55 up to 120 hp. Available in multiple sizes and pitches for both S-drives and shafts. Made of extremely strong and durable nibral (nickel-bronze-aluminum) alloy.



- Powerful thrust even in reverse thanks to patented blade geometry
- Smooth, low-noise operation with minimal vibrations
- Safe opening with quick response in both forward and reverse
- Rubber bushing and galvanic isolation (hubs for S-drives)

Note! For a complete propeller, order one blade kit and one hub kit. Propeller size has to be calculated to match engine and gear ratio, please contact your Volvo Penta dealer.

Blade kits

S-Drive & Shaft		Shaft		S-Drive & Shaft		Shaft	
Ø x PITCH	 LH	 RH	Ø x PITCH	 LH	 RH		
20 x 14	3583917	3583918	22 x 18	3583923	3583924		
21 x 15	3583919	3583920	22 x 20	3583925	3583926		
22 x 16	3583921	3583922					

Blade kit includes: Blades, hex key for locking screw (pos 10), lubricant grease and installation instruction.

Hub kits

Hub kit for S-drives		Hub kit for metric standard shaft (1:10 taper)	
110S, 120S, MS25S, 130S, 150S	3583927	25 mm shaft (key 6 mm)	3583928
Hub kit for SAE standard shaft (1:16 taper)		30 mm shaft (Key 8 mm)	3583929
1 1/4" shaft (key 5/16")	3583931	35 mm shaft (Key 10 mm)	3583930
1 1/2" shaft (key 3/8")	3583932	40 mm shaft (Key 12 mm)	3584137

Hub kit includes: Anodes, locking fluid and installation hardware listed in the table below. Nut (M16 & M20) and key are excluded from hub kit.
 * Hub pre-drilled with 8 mm hole. Require final machining to the required shaft diameter and taper. Suitable for shafts up to 31,75 mm (1 1/4").

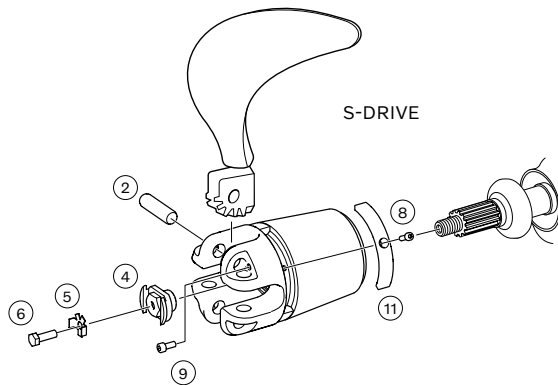
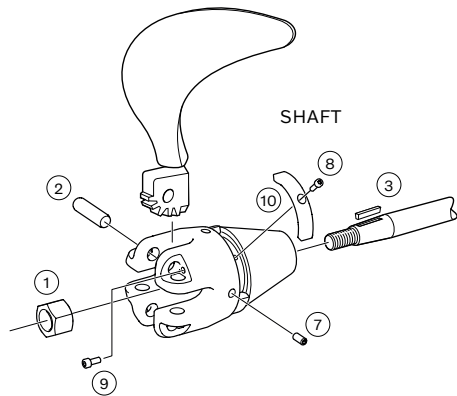

Installation hardware, 4-blade folding propeller

Pos	Part No	Qty	Item
1	873473	1	Nut, prop shaft, M16
1	873486	1	Nut, prop shaft, M20
1	3587422	1	Nut, prop shaft, M24 ⁴⁾
	873475	1	Tab washer, M16
	873488	1	Tab washer, M20
	873506	1	Tab washer, M24
2	3583951	4	Shaft ^{1,2)}
3	873474	1	Key, prop shaft, Ø25mm
3	873487	1	Key, prop shaft, Ø30mm
3	873496	1	Key, prop shaft, Ø35mm

Pos	Part No	Qty	Item
3	873505	1	Key, prop shaft, Ø40mm
4	3584466	1	Propeller nut ¹⁾
5	3851994	1	Lock washer ¹⁾
6	946730	1	Hexagon screw ¹⁾
7	948000	2	Screw ²⁾
8	963677	3	Hex. socket screw M5x16 ^{1,2)}
9	963695	4	Hex. socket screw M6x14 ^{1,2)}
		3	Anode ^{2,3)}
		3	Anode ^{1,3)}
	23284156	1	Locking fluid (10 ml) ^{1,2)}

1) Included in hub kit for S-drive. 2) Included in hub kit for shaft. 3) For part number, see chapter "Related product". 4) Included in hub kits for 35mm and 40mm shaft.

Fixed propellers for S-drive

Proven performance for saildrives

Our fixed propellers are exclusively designed for Volvo Penta saildrives. Manufactured using high-quality, durable aluminum alloy and with a rubber bushing in the hub, you get efficient and comfortable motoring - and at the same time secure the service life of your saildrive.

Durable aluminum alloy
developed to withstand corrosion
and cavitation damage.

Epoxy coating which is
highly-resistant to abrasion.

Rubber hub bushing
minimizes stress on the
drivetrain caused by gear
changes.

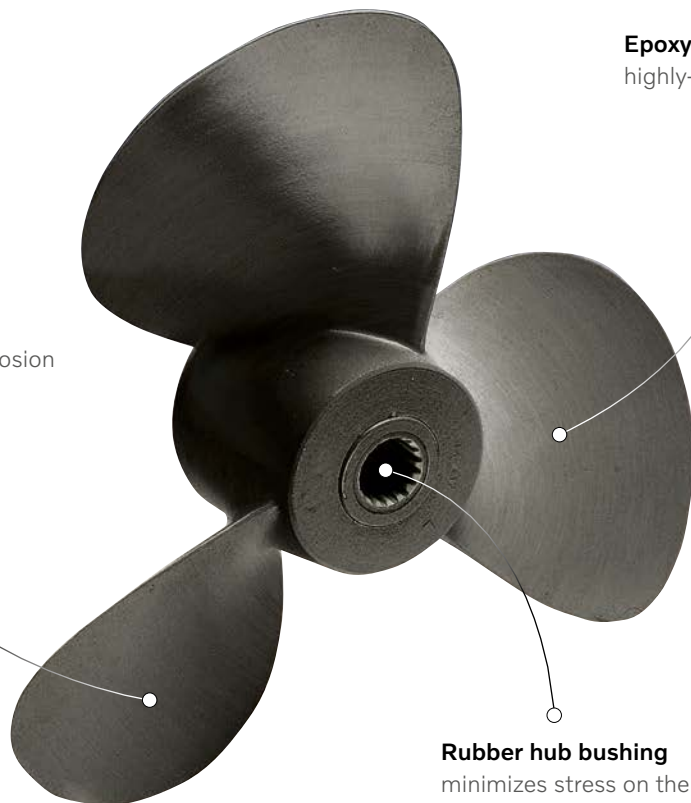

Fixed propellers for S-drive



2 & 3-blade aluminum propeller

Specifically designed for your Volvo Penta saildrive to ensure efficient and comfortable motoring. Available for left-hand rotation in multiple sizes and pitches. Our 2 and 3-blade fixed propellers also include:



- Durable aluminum alloy withstands corrosion and cavitation damage.
- Shock absorbing rubber bushing to secure the service life of the drive.
- Abrasion-resistant epoxy coating.



2-blade aluminum propeller (110S, 120S, MS25S, 130S 150S)

Ø x PITCH		Ø x PITCH	
14 x 7	23478911	16 x 13	23478917
14 x 8	23478912	17 x 14	23478918
14 x 9	23478913	17 x 16	23478919
14 x 11	23478914	17 x 17	23478920
15 x 11	23478915	19 x 17	23478921
16 x 11	23478916		

2-Blade aluminum propeller (50S, 100S)

Ø x PITCH		
14 x 8	839514	MD6A
16 x 11	839191	MB10A, MD11C

3-blade aluminum propeller (110S, 120S, MS25S, 130S 150S)

Ø x PITCH		Ø x PITCH	
14 x 9	23478961	17 x 12	23478967
14 x 11	23478962	17 x 13	23478968
14 x 12	23478963	17 x 14	23478969
15 x 12	23478964	17 x 15	23478970
15 x 13	23478965	17 x 16	23478971
16 x 11	23478966	18 x 16	23478972

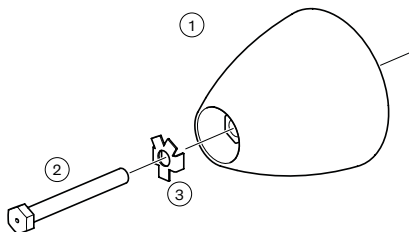

Installation hardware, fixed propellers for S-drives 110S, 120S, MS25S, 130S, 150S

Pos	Part No	Qty	Item
1	23749222		Propeller cone kit
2	23748333		Screw *

Pos	Part No	Qty	Item
3	23680979		Lock washer*

* Included in propeller cone kit

Related products

Genuine Volvo Penta sacrificial anodes

Genuine Volvo Penta anodes are made to sacrifice themselves in order to protect your drive and propeller from galvanic corrosion.

Volvo Penta now recommends the use of Aluminum anodes in salt and brackish water instead of zinc for salt water as previously recommended. Volvo Penta will gradually phase out and replace most of our zinc anodes with aluminum anodes.

Aluminum anodes provide:

- 30% higher corrosion protection capacity
- up to 20-40% longer life span in salt water, compared with similarly-sized zinc anodes
- lower environmental impact
- better choice also for brackish water

Volvo Penta has worked and invested intensively in the aluminum alloy manufacturing processes and quality control system, resulting in a high degree of purity of the alloy.

When installing a new anode it is important to have good contact between the anode and the surface to which it is connected. Read the Operator's Manual for detailed information regarding maintenance and replacing anodes for your Volvo Penta product.



Optimal protection

Volvo Penta anodes feature, when needed, an internal reinforcement made from an alloy that does not erode. This also ensures a reliable electrical connection between the anode and the drive.

Choose the right anode

Here are our general recommendations how to choose the anode for the type of water where the boat is used:

	Salt Water*	Brackish Water*	Fresh Water
Aluminum	✓	✓	—
Magnesium	—	—	✓

* For some older drives, zinc anodes (marked with Zn) are provided for salt and brackish waters instead of aluminum anodes.

If an anode has been exposed to air for a long time, the anode can be covered by a passivating surface film that prevents it from working properly. Consider reactivating the anode by grinding it with emery paper before launching the boat.

NOTE! Do not use sandpaper, wire brush or other steel tools when cleaning, as these may damage the galvanic protection.

Factors like water flow, salinity, temperature, pollution levels and stray current considerably impact the anodes' life span.



Anodes for drives and propellers

Aquamatic Sterndrive - Single Prop Drives

Lower Gear	Salt and Brackish Water (Al*)	Fresh Water (Mg)
100 Drive	875810 (Zn)	—
200-290, SP	875815 (Zn)	876137
Spray Plate		
SX	3863193	3855412
SX-A	23164609	3888815
Transom Shield		
200-280	832598 (Zn)	873179
290, SP	3588770	3588768
SX	3586461	3855610
SX-A	23164611	3888818

Aquamatic Sterndrive - Duoprop Drives

Lower Gear	Salt and Brackish Water (Al*)	Fresh Water (Mg)
280, 290, DP	23974010	876138
Spray Plate		
DP-S, DP-SM	3863193	3855412
DPS-A, DPS-B, FWD	23164609	3888815
DPR, DPH, DPI	23520859	23520860
DPX	876638 (Zn)	
Transom Shield		
280	832598 (Zn)	873179
290, DP	3588770	3588768
DP-S, DP-SM	3586461	3855610
DPS-A, DPS-B, FWD	23164611	3888818
DPH, DPR, DPI	3588770	3588768
DPX	23813192	24042665
Exhaust Pipe		
DPH, DPI, DPR	21868042	21868041
Fork		
	23986753	23986752
Intermediate house		
DPX	24007660	3863480

S-Drives

Lower Gear	Salt and Brackish Water (Al*)	Fresh Water (Mg)
110S	875812 (Zn)	876603
120S, MS25S	23973978	876604
130S, 150S (2 piece anode)	23615636	22651247

Folding Propellers

S-Drive	Salt and Brackish Water (Al*)	Fresh Water (Mg)
2-blade & 3-blade	23974203	3858400
4 -blade propeller	23974205	3584443
Shaft		
2-blade propeller	23974207	3888493
3-blade propeller (use anode for shaft mounting)	—	—
4-blade propeller	23974203	3858400

Volvo Penta IPS

	Salt, Brackish and Fresh Water
Lower Gear	3593981
Transom anode IPS1/10	23172849
Transom anode IPS15, IPS2/20, IPS3/30	23172856

* For some older drives, cadmium-free zinc anodes (marked with Zn) are provided for salt and brackish water environments instead of aluminum anodes.

Related products

Line cutter for Volvo Penta IPS, DPH and DPI drives

The line cutter is an easy to install accessory that provides additional protection for your drive. It is designed to cut through ropes, fishing lines, plastic bags and nets before they can enter between the propellers and possibly cause damage to the propeller shaft sealing. The line cutter is installed between the propellers using the existing propeller nut.



- Cuts up ropes, fishing lines, plastic bags etc.
- Protects propeller shaft sealing.
- Easy to install using existing bolts.
- Requires no drilling.
- Adds no drag or fuel consumption.

Note! The line cutter is included as standard on DPI drives, all IPS 15 drives and on late production of IPS 1, IPS 2 and IPS 3 drives, serial numbers available in the table below.

Line cutter for Volvo Penta DPH and DPI drives with type H propellers

Fits	Part No.	Qty	Diameter	Material
Type H propellers ¹⁾	23777877	1	95 mm / 3.7"	316 Stainless steel

1) Included as standard on DPI drives.

Line cutter for Volvo Penta IPS

Fits	Part No.	Qty	Diameter	Material
IPS 1 ¹⁾	23062729	1	95 mm / 3.7"	316 Stainless steel
IPS 15 ²⁾	21913550	2	105 mm / 4.1"	316 Stainless steel
IPS 2 ¹⁾	21686494	1	120 mm / 4.7"	316 Stainless steel
IPS 3 ¹⁾	21686496	1	140 mm / 5.5"	316 Stainless steel

2) Included as standard from serial number: IPS 1 = 3940018643, IPS 2 = 3950002140, IPS 3 = 3950001773.

3) Included as standard from production start.

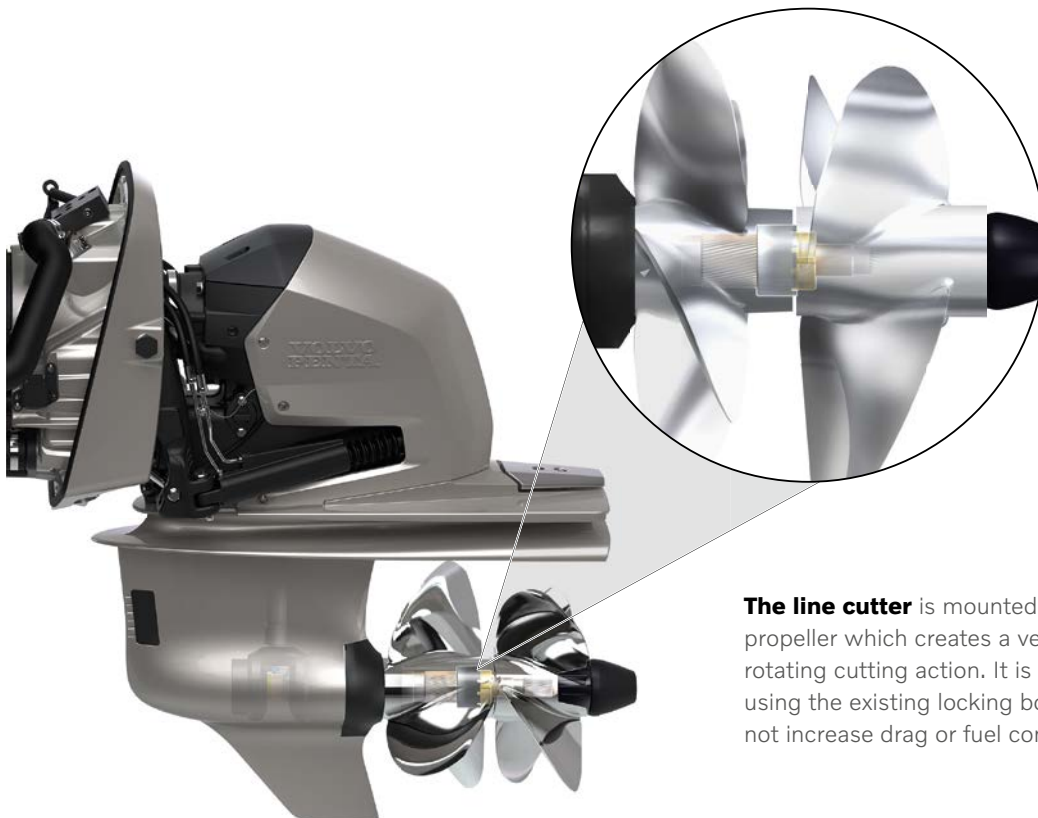

The line cutter is mounted to the rear propeller which creates a very efficient rotating cutting action. It is easy to install using the existing locking bolts and does not increase drag or fuel consumption.

Related products

Grease for propeller components

Volvo Penta water-resistant grease is designed to provide excellent adhesion, water resistance and load-carrying properties, as well as long-term protection against corrosion. It is a multi-purpose premium grease and is highly recommended for greasing propeller shafts, folding propellers and all other propeller components.

- Highly adhesive and cohesive structure.
- Superb resistance to water washout.
- Excellent corrosion protection and lubrication endurance.



Description	Quantity	Grade	Color	Part No
Tube	25g	NLGI 2	Blue	828250
Cartridge	400g	NLGI 2	Blue	22618330

Grease for traditional stuffing boxes

Water resistant grease for traditional propeller shaft stuffing boxes fitted with a greasing cup. Lubricates, seals and protects against corrosion. Copes with prolonged loads without losing its protective characteristics.



Description	Quantity	Grade	Color	Part No
Propeller Shaft Grease	500g	NLGI 3	Yellow	3809449

Related products

Marine synthetic transmission oils

High-performance fully synthetic transmission oils, specifically designed to ensure excellent load-carrying capability over wide operating temperatures. Provides optimal shift performance and maximum protection against wear and corrosion. Advanced marine additive technology includes unique capabilities to minimize damage due to water contamination. All this ensures significant advantages over conventional transmission oils and contributes to smooth operation and long-term health for the drive.

IPS and Aquamatic synthetic transmission oil 75W-90

Description	Quantity	SAE	Part No
Plastic bottle	1 Litre	75W-90	22479650
Plastic container	5 Litre	75W-90	22479648
Plastic container	20 Litre	75W-90	22479647

For SX, SP-A2, SP-C (except ratio 2.15:1), DPS, FWD, DPI, DPH (except ratio 1.59:1), DPR, DPX, XDP, DP-A2 to DP-E, all IPS drives, S-drive 120S-E, reverse gear MS2A/L-E, MS4, MS5.



Synthetic transmission oil 75W-140

Description	Quantity	SAE	Part No
Plastic container	5 Litre	75W-140	22574246



Transmission oil 80W-90

Lubrication properties protect drive and transmission even under heavy load. Also provides excellent corrosion protection.

Grade: API GL-5

Description	Quantity	SAE	Part No
Plastic container	5 Litre	80W-90	3809445

For AQ100, 280DP, 290DP, DP-A/A1 (except drives manufactured before 1986, for 30 or 40 series engine, and has previously used engine oil in the drive, continue to use engine oil).





Please contact your local Volvo Penta dealer for further information. Please note that products illustrated may differ from production models. Not all models and accessories are available in all markets, and standard equipment may vary between different markets. Every effort has been made to ensure that facts and figures are correct at the time of publication. However, Volvo Penta reserves the right to make changes without prior notice at any time.

V O L V O P E N T A